

Hakki Pilke

Falcon 35

FIREWOOD PROCESSOR SPARE PARTS MANUAL



MAASELÄN KONE OY

Valimotie 1, FI-85800 Haapajärvi, Finland

tel. 08-7727300

info@hakkipilke.fi

www.hakkipilke.fi

Contents

1.1	Exploded view of the machine.....	5
1.2	Parts list of the exploded view.....	6
1.3	Log table (50012752).....	8
1.4	Log table parts list (50012752).....	9
1.5	Log table tensioning roller (37524).....	10
1.6	Log press (50004099).....	11
1.7	Parts list.....	12
1.8	Splitting mechanism trigger (50033724).....	13
1.9	Oil tank (50009983, rev. B, as of 6/2016).....	14
1.10	Oil tank (50009983 rev. B), parts list.....	15
1.11	Frame (50009988 rev. A as of 12/2016).....	16
1.12	Cover assembly (50016790 rev. B as of 12/2016).....	18
1.13	Cover assembly parts list (50016790 rev. B as of 12/2016).....	19
1.14	Saw drive head (50010223 A).....	20
1.15	Saw drive head parts list.....	21
1.16	Splitting mechanism (50029215 rev. A).....	22
1.17	Operating lever (50012229).....	23
1.18	Splitting mechanism trigger (50012252).....	23
1.19	Splitting end guard (50013269).....	24
1.20	Log measuring device (50016021 rev. C).....	25
1.21	Splitting mechanism cylinder (50016295).....	26
1.22	Saw chain lubrication pump (50016796).....	27
1.23	In-feed conveyor drive roller assembly (50017534).....	28
1.24	Out-feed conveyor turning device (50017575).....	29
1.25	Turning device (50017575) parts list.....	30
1.26	Connection block.....	31
1.27	Connection block 2.....	32
1.28	Control valve (50018479).....	33
1.29	Flow control valve (50016299).....	34
1.30	Auxiliary device control valve assembly (35202, accessory).....	35
1.31	Upper section of the out-feed conveyor.....	36
1.32	Out-feed conveyor belt (10317).....	37
1.33	Lower section of the out-feed conveyor.....	38
1.34	Hydraulic pump + multiplier gearbox (50008181_B).....	39
1.35	Splitting cylinder (50025390).....	40
1.36	Stroke limiter valve (50033698).....	41
1.37	Control panel (50018471).....	42

1.38	Control panel parts list (50018471)	Virhe. Kirjanmerkkiä ei ole määritetty.
1.39	Splitting valve assembly (50009823 Rev. B)	44
1.40	Saw valve assembly (50016293)	45
1.41	High-speed valve (50018615)	46
1.42	In-feed conveyor cock (35203, accessory).....	47
1.43	Out-feed conveyor relief valve (50036562).....	48
1.44	Electric motor assembly (50008305)	49
1.45	Parts list of the electric motor assembly (50008305).....	50
1.46	Saw downward pressure control valve assembly (50033694)	51
1.47	Relief valve (50033695)	52
1.48	Control valve of splitting blade, Accessory	53
1.49	Hydraulic control for splitting blade, accessory (50042223)	54
1.50	Splitting blade height adjustment lever	55
1.51	Splitting cylinder check valve on the arm side (50018545)	56
1.52	Divider.....	57
1.53	Small pump check valve (50036618) (Combi model only)	58
1.54	Large pump check valve (50036619) (Combi model only)	59
1.55	Saw control valve, accessory (50044723).....	60
1.56	Auxiliary device control valve (37638, accessory)	61
1.57	Log table extra roller (35209, accessory).....	62
1.58	Parts list of the log table extra roller (35209, accessory)	63

1.1 Exploded view of the machine

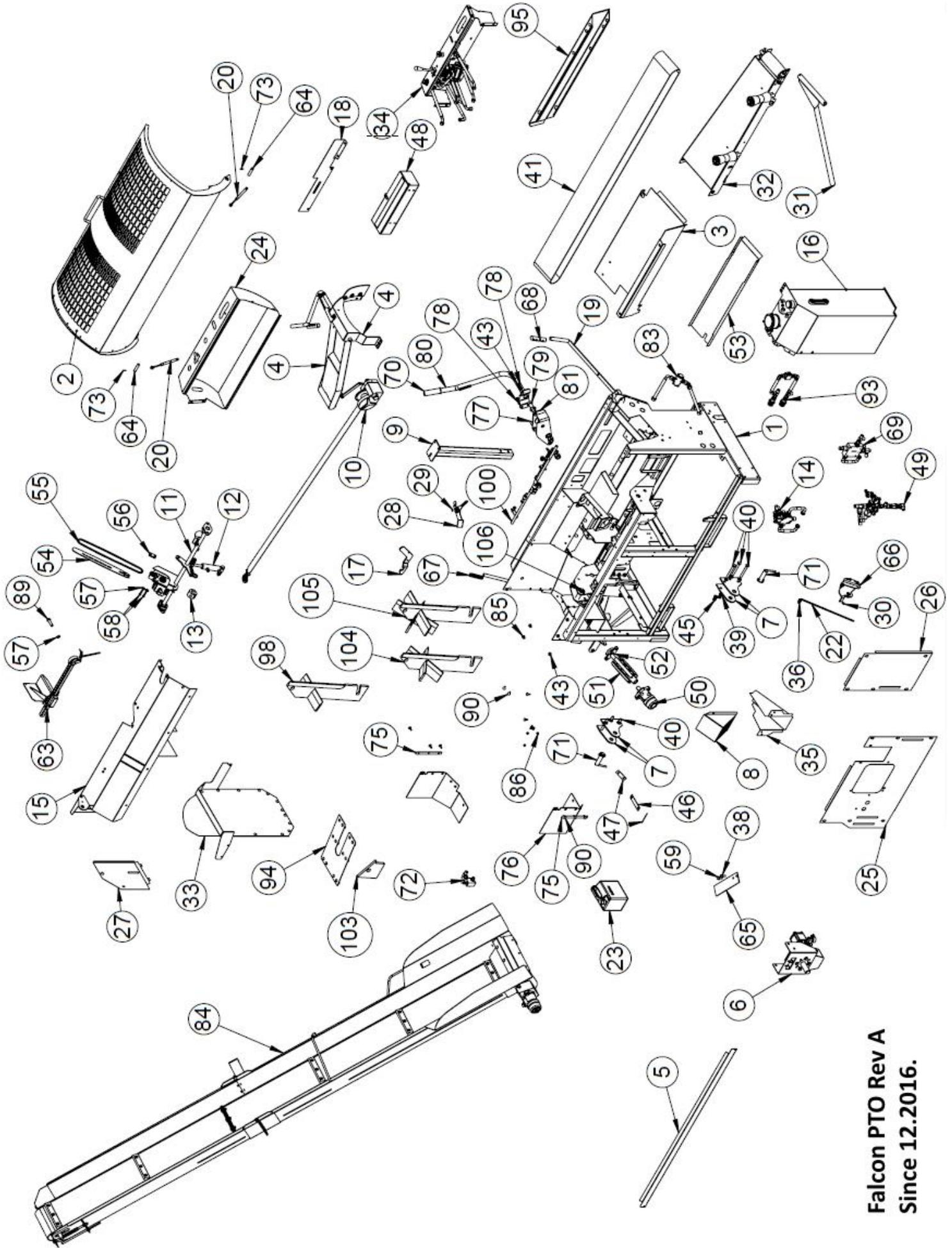

Falcon PTO Rev A
Since 12.2016.

1.2 *Parts list of the exploded view*

Part	Item	Part number	Pcs
105	8-way splitting blade	50031909	1
104	6-way splitting blade	50025129	1
103	Rear support bypass	50030150	1
102	Flange bolt M8x16	96172	3
101	Trigger	50015757	1
100	Splitter linkage	50029215	1
99	Stopper plate	50028849	1
98	4-way splitting blade	50025126	1
97	Lock screw	96387	1
96	Lock screw	96411	3
95	Baffle	50016149	1
94	Splitting groove sawdust guard	50025304	1
93	In-feed conveyor valve assembly	50016294	1
92	Lock screw	96314	1
91	Washer	96049	4
90	Lock screw	96191	13
89	Hex socket screw	96002	1
88	Hex screw	96168	1
87	Washer	96061	2
86	Locking nut	96222	11
85	Lock screw	96187	3
84	Out-feed conveyor hydr. drive	50016803	1
83	Stroke limit valve Falcon	50029192	1
82	Locking latch	50028231	1
81	Splitting blade adjuster	50028175	1
80	Handle	50025177	1
79	Hex screw	96429	2
78	Pressure spring 3.5x22x38	95014	2
77	Hex screw	96110	2
76	Splitting groove mat	50025104	1
75	Plate reinforcement	50008967	2
74	Splitting groove mat	50025104	1
73	Spring pin	96354	2
72	Out-feed conveyor relief valve 85 bar	61216	1
71	Drawbar pin 28x130	95717	2
70	Sheath 32 mm	95648	1
69	High-speed valve assembly	50016292	1
68	Handle	95595	2
67	Handle	95034	1
66	Return piece	50009805	1
65	Splinter guard	50012933	1
64	Cage pin	47967	2
63	Log length limiter	50016021	1
62	Hex screw	96129	2
61	Hex nut	96199	3
60	Hex nut	96196	1
59	Hex screw	96146	2
58	Hex screw	96291	2
57	Washer	96085	3
56	Saw bar fastening plate	10044	1
55	Saw chain 68 link 0.325 1.5 mm	95668	1

54	Saw bar, 16 inches	95147	1
53	Sawdust trough	50015566	1
52	UC 205 Bearing	95318	1
51	In-feed conveyor drive roller	50000467	1
50	Hydraulic motor MSEPM-200	97308	1
49	Splitting valve assembly	50009823	1
48	Tool box	50005582	1
47	Rubber fastening plate	37595	2
46	Rubber fastening lower plate	37596	1
45	Locking nut	96211	6
44	Locking nut	96068	5
43	Locking nut	96218	4
42	Locking nut	96214	2
41	In-feed conveyor belt	95128	1
40	Hex screw	96295	6
39	Washer	96051	12
38	Washer	96058	11
37	Washer	96054	4
36	Stopper	50009248	2
35	Sawdust trough	50004189	1
34	Valve mount	50013005	1
33	Splitting end guard	50013269	1
32	Log table extension	50012752	1
31	Support for log table extension	50012751	1
30	Retaining ring	96038	1
29	Retaining ring	96380	1
28	Trigger	50012252	1
27	End plate	50011820	1
26	Rear guard plate	50011765	1
25	Rear cover	50011766	1
24	Control panel	50011375	1
23	Oil container 3l	95647	1
22	Safety rod	50002889	1
21	Hex socket screw	96023	1
20	Gas spring 4498	95562	2
19	Return lever	50002587	1
18	Guard	50007025	1
17	Conveyor catch	50004511	1
16	Tank assembly	50009983	1
15	Cover assembly	50016790	1
14	Saw valve	50016293	1
13	Support bearing	50010215	1
12	Cutting cylinder	50016295	1
11	Drive head	50010223	1
10	Out-feed conveyor winch	37151	1
9	Winch fastening pipe	10825	1
8	Sawdust guide	37551	1
7	Lifting arm lug	37454	4
6	Gear + pump	50008181	1
5	Baffle	37447	1
4	Wood gripper	50004099	1
3	Log table cover	50007151	1
2	Upper cover	37430	1
1	Frame slide, etc.	50009988	1

1.3 Log table (50012752)

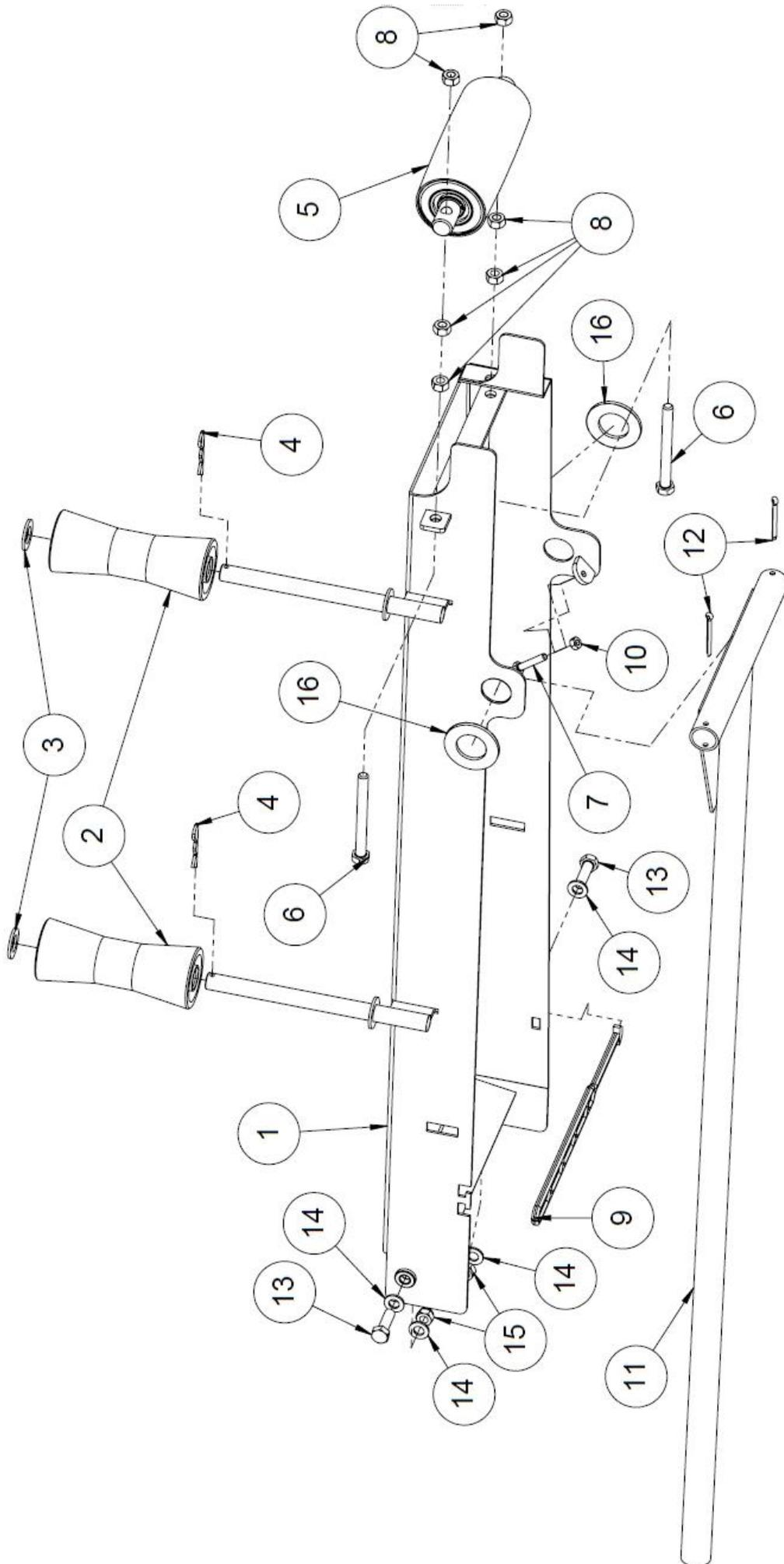

1.4 Log table parts list (50012752)

Number	Name	Part number	Dimensions	Pcs
16	Washer	96410	A36	2
15	Locking nut	96218	M12	2
14	Washer	96058	A12	4
13	Hex screw	96148	M12x40	2
12	Split pin	96250	5x50	2
11	Support for log table extension	50012751		1
10	Hex nut	96196	M8	1
9	Rubber cover/fastener	95645		1
8	Hex nut	96200	M12	6
7	Hex screw	96123	M8x40	1
6	Hex screw	96142	M12x120	2
5	Tensioning roller	37524		1
4	Hitch pin	96208		2
3	Washer	96053	A20	2
2	Keel roller	95001		2
1	Log table extension	50012750		1

1.5 *Log table tensioning roller (37524)*

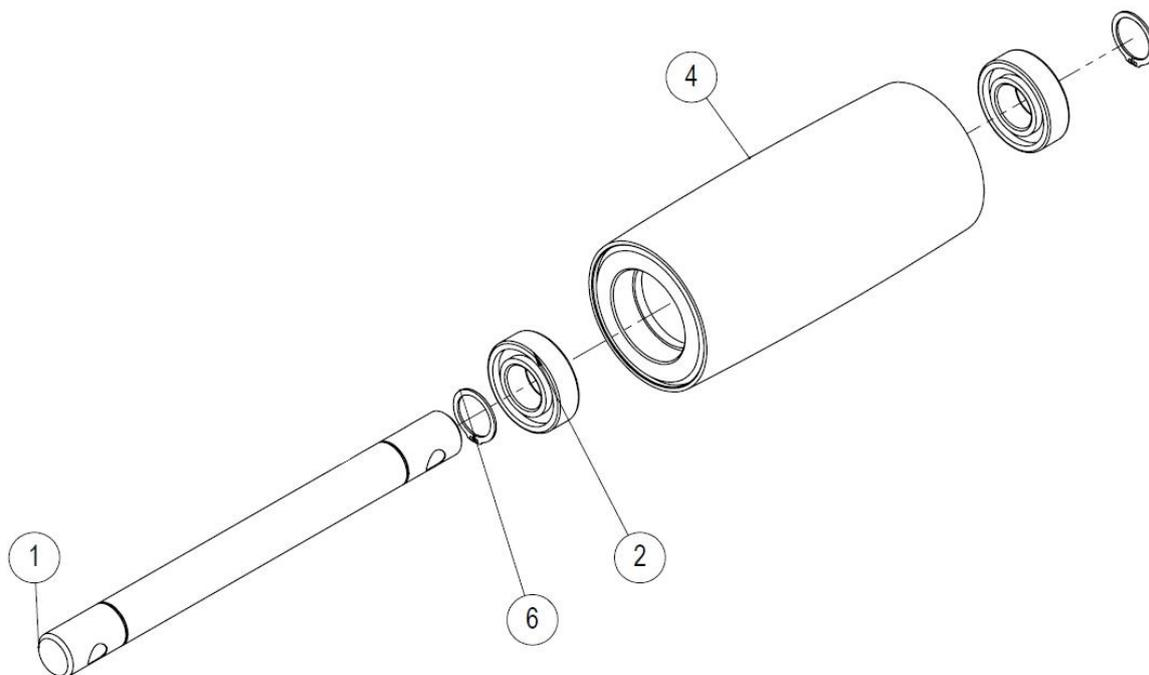

No.	Part number	Name	Pcs
1	37529	Tensioning roller shaft	1
2	95050	Bearing, SKF - 6205	2
4	37509	Tensioning roller	1
6	96042	Retaining ring DIN 471 25	2

1.6 Log press (50004099)

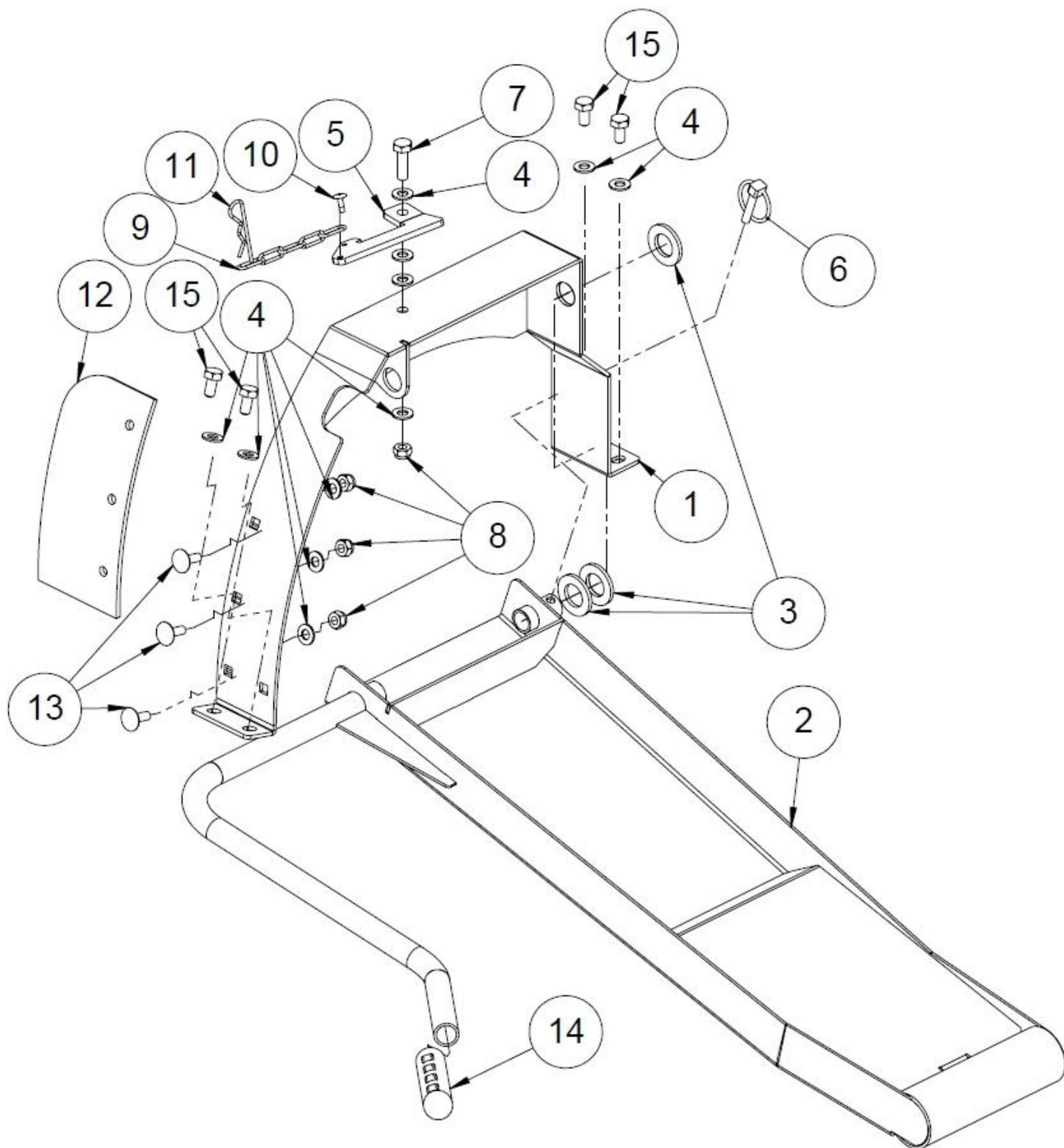

1.7 Parts list

No.	Item	Part number	Dimensions	Pcs
15	Hex screw	96138	M10x20	4
14	Handle	95595		1
13	Lock screw	96186	M10x25	3
12	Finger guard	50012922		1
11	Ring pin 8 mm	96242		1
10	Pop rivet	96271	4.8x16.5	1
9	Chain 3 mm	95480		1
8	Locking nut	96068	M10	4
7	Hex screw	96097	M10x35	1
6	Ring pin 8 mm	96242		1
5	Extension lock	50004101	PL6 65x132.50	1
4	Washer	96049	A10	11
3	Washer	96054	A24	3
2	Wood gripper	50003671		1
1	Wood gripper fastener	50003683		1

1.8 Splitting mechanism trigger (50033724)

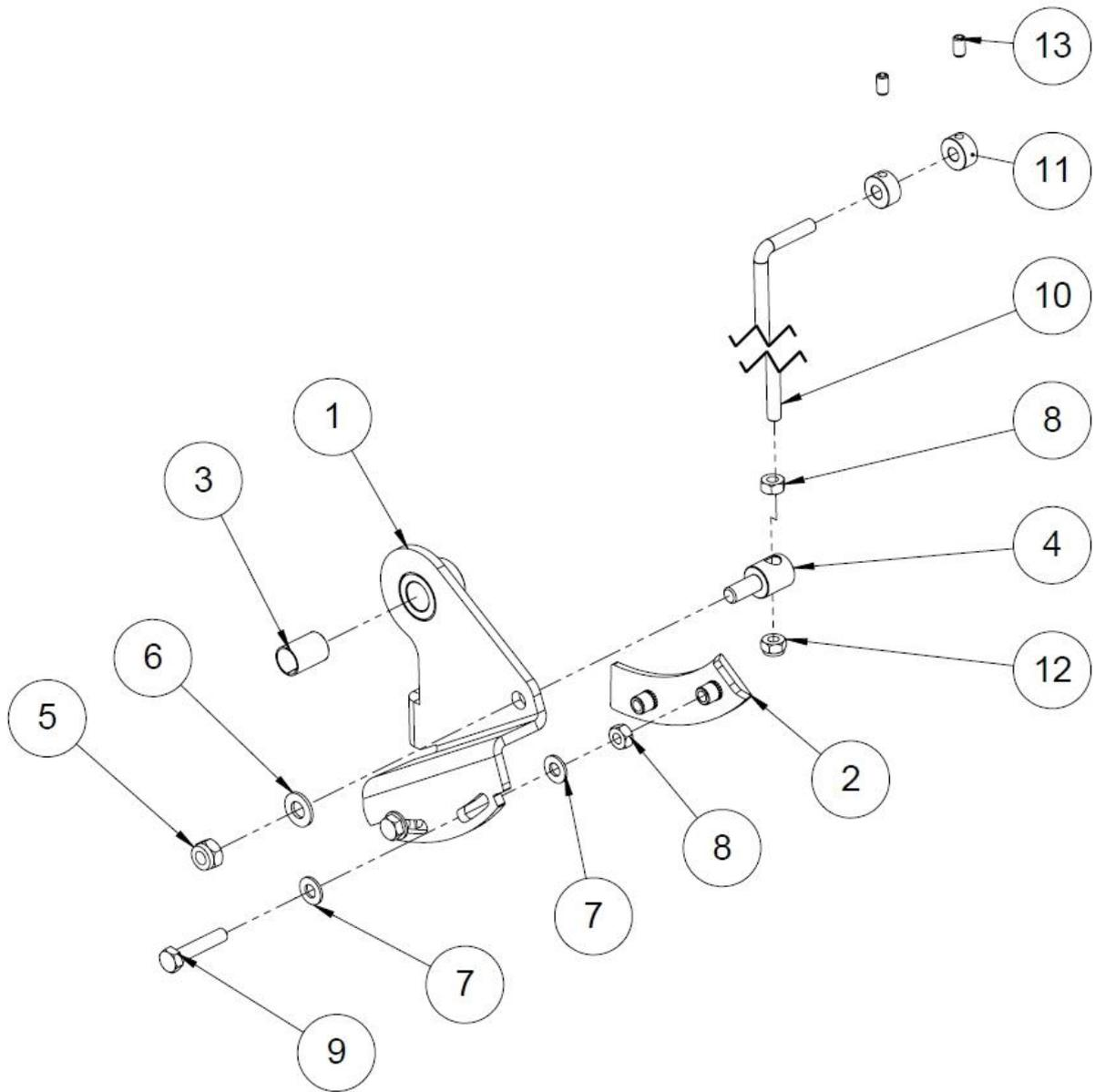

No.	Item	Part number	Dimensions	Pcs
13	Clamping screw	96362	M8x12	2
12	Locking nut	96222	M8	1
11	Stopper	50009248		2
10	Safety rod	50002889		1
9	Hex screw	96167	M8x40	2
8	Hex nut	96196	M8	3
7	Washer	96061	A8	4
6	Washer	96049	A10	1
5	Locking nut	96068	M10	1
4	Joint nipple	50006075		1
3	Slide bearing	95064	18x16x25	1
2	Return mechanism component assembly	50016014		1
1	Return piece	50033723		1

1.9 Oil tank (50009983, rev. B, as of 6/2016)

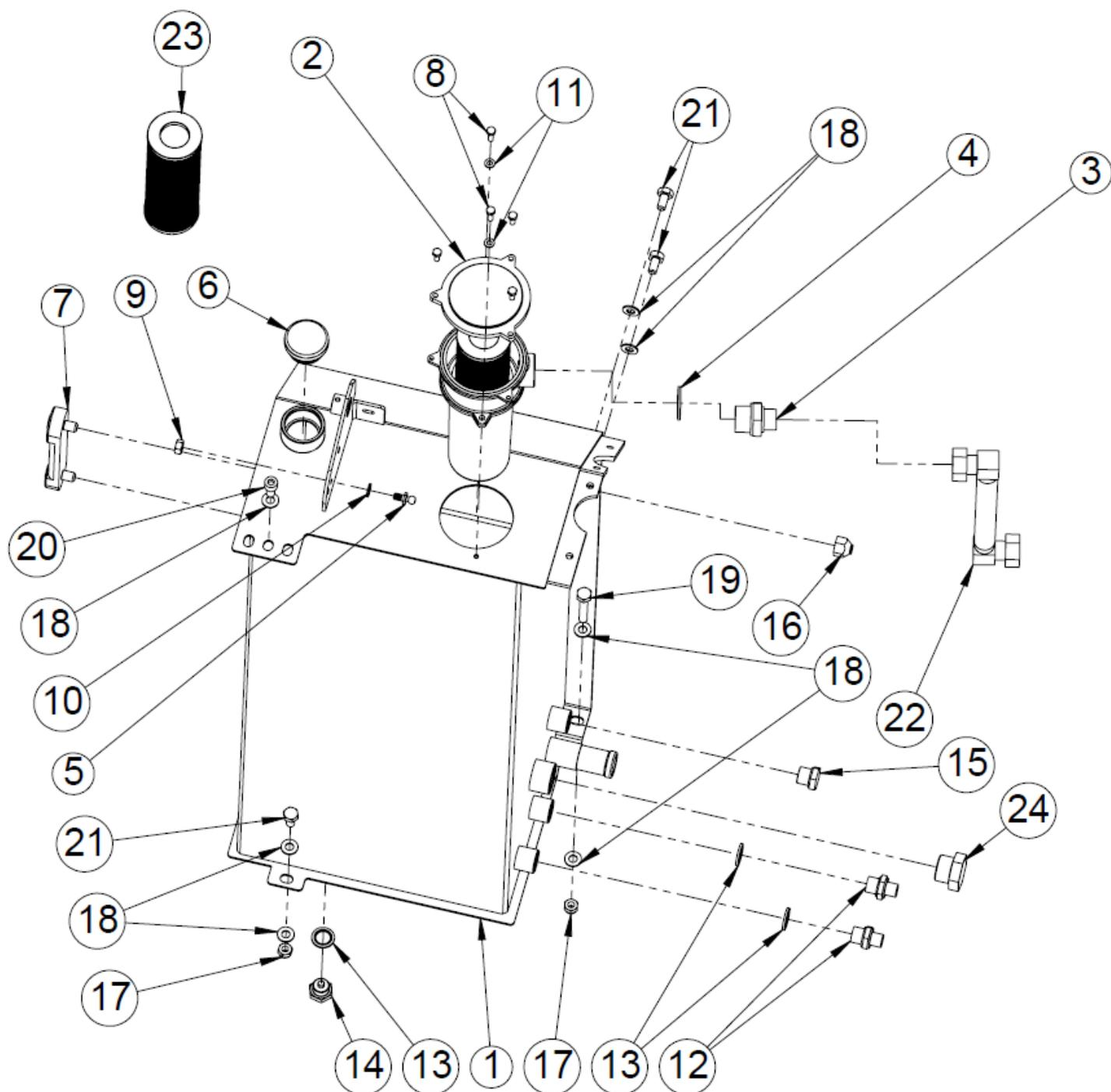

1.10 Oil tank (50009983 rev. B), parts list

No.	Item	Part number	Dimensions	Pcs
24	1" hex plug	97612		1
23	Filter insert	97348		1
22	Hydraulic hose, 750 mm ¾"	97122		1
21	Hex screw	96138	M10x20	3
20	Hex socket screw	96022	M10x20	1
19	Hex screw	96100	M10x60	1
18	Washer	96049	A10	7
17	Locking nut	96068	M10	2
16	Internal thread plug 3/8"	97376	Ø22	1
15	Plug 1/2" uk	97261		1
14	Base plug with magnet 1/2"	97399		1
13	USIT ½"	97213		3
12	Double nipple 3/8" x 1/2"	97203		2
11	Washer	96060	A6	2
10	Washer	96061	A8	1
9	Hex nut	96199	M10	1
8	Hex screw	96135	M6x20	2
7	Oil level sight glass	97552		1
6	Filler cap	97429		1
5	Gas spring ball head M8 D10	95542		1
4	USIT, 1"	97215		1
3	Double nipple, straight ¾" x1	97208		1
2	filter box, incl. filter	97349		1
1	Tank	50009953		1

1.11 Frame (50009988 rev. A as of 12/2016)

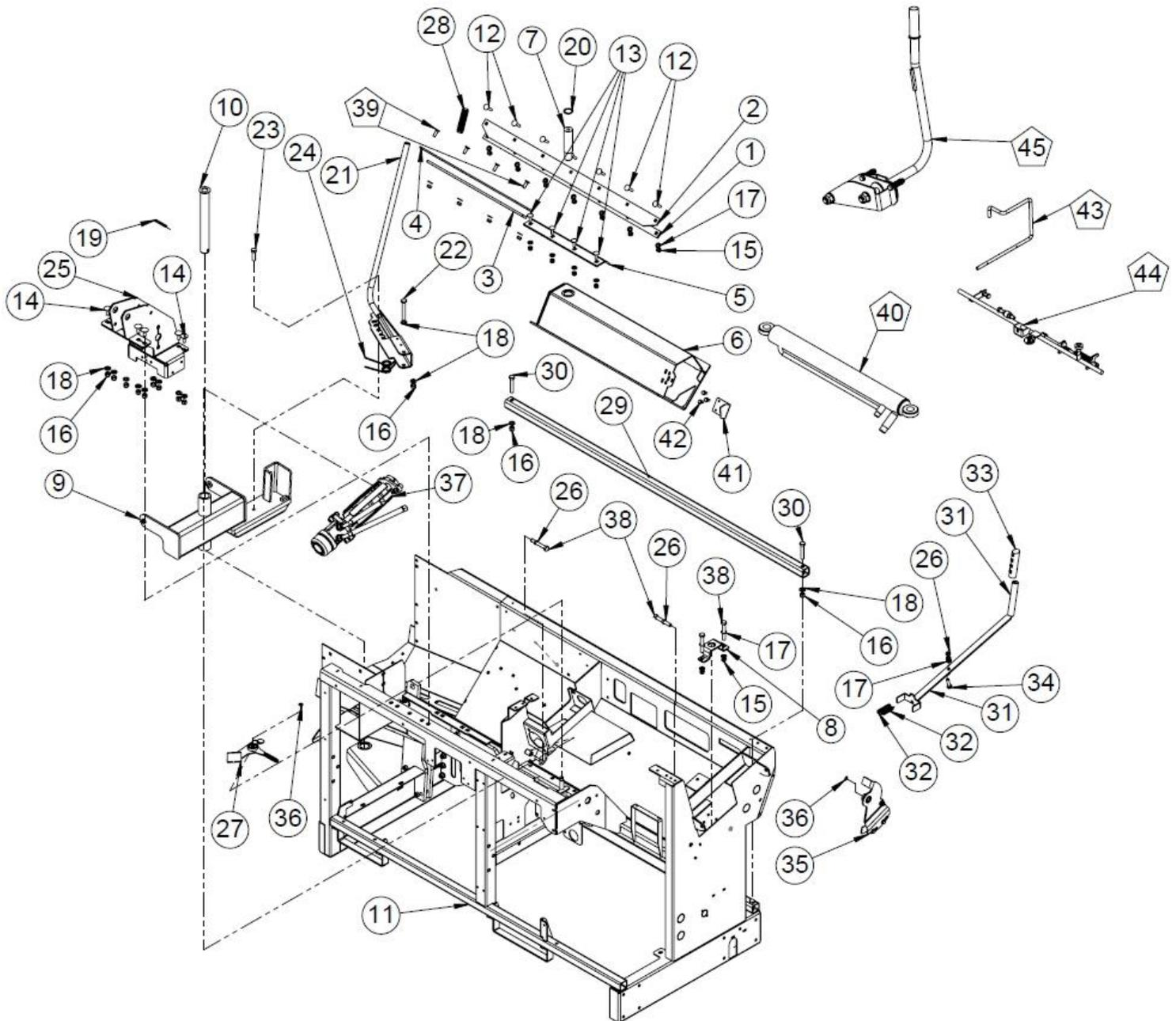

No.	Item	Part number	Time of commissioning	Dimensions	Pcs
45	Splitting blade lever, COMPLETE	50031349	12/2016-->		1
44	Splitter linkage	50029215	12/2016-->		1
43	Locking latch	50028231	12/2016-->	Ø12	1
42	Flange bolt M8x16	96172			3
41	Trigger	50015757		PL4	1
40	Cylinder	50025390	12/2016-->		1
39	Hex socket screw	96008	12/2016-->	M10x30	4
38	Hex screw	96171		M12x80	4

37	Feed drive roller assembly	50017534			1
36	Retaining ring	96380		12	2
35	Return piece	50009805			1
34	Hex screw	96129		M10x40	1
33	Handle	95595			1
32	Draw spring	95423			2
31	Return lever	50002587			1
30	Hex screw	96110		M12x70	2
29	Conveyor pipe	50006733		40x40x4 L=1690	1
28	Handle	95034			1
27	Trigger	50012252			1
26	Hex nut	96199		M10	4
25	Push bar and gear lugs	50010172			1
24	Double torsion spring	95432			1
23	Hex screw	96107		M12x45	1
22	Hex screw	96111		M12x90	1
21	Out-feed conveyor stopper	50012586			1
20	Retaining ring	96240		35	1
19	Spring pin	96079		8x60	1
18	Washer	96058		A12	13
17	Washer	96049		A10	20
16	Locking nut	96218		M12	12
15	Locking nut	96068		M10	17
14	Lock screw	96188		M12x30	9
13	Lock screw	96387		M10x30	4
12	Lock screw	96314		M10x40	7
11	Frame	50007548			1
10	Turning device pin	50006392			1
9	Out-feed conveyor swivel device	10600			1
8	Cylinder mounting	50015863		PL5	1
7	Cylinder pin	50015810		Ø35	1
6	Slide	50015760			1
5	Slide fastener	50015680		PL6	1
4	Slide fastener	50015679		PL6	1
3	Baffle	50015678		PL8	1
2	Slide fastener	50015673		PL6	1
1	Baffle	50015674		PL8	1

1.12 Cover assembly (50016790 rev. B as of 12/2016)

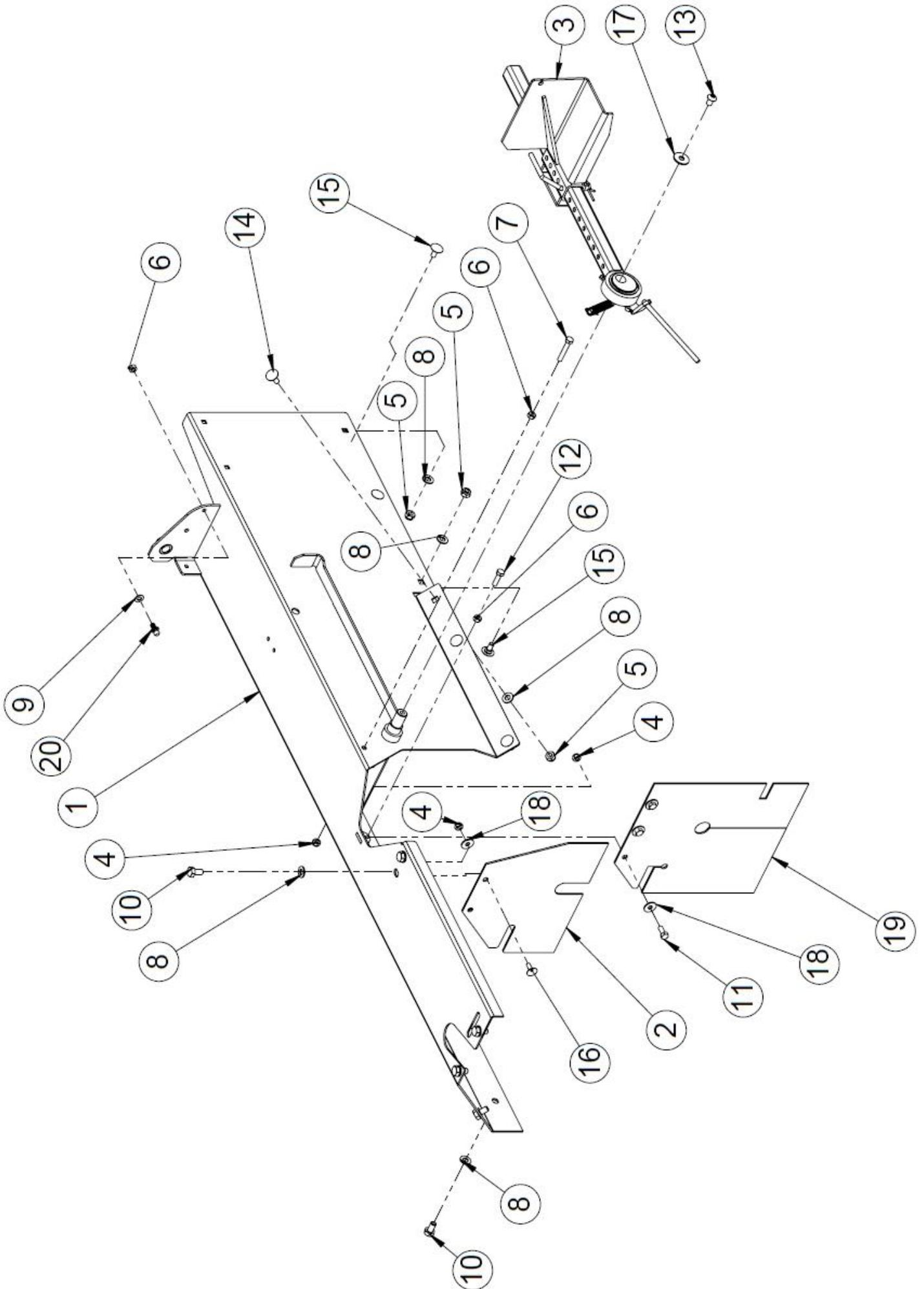

1.13 Cover assembly parts list (50016790 rev. B as of 12/2016)

No.	Item	Part number	Dimensions	Pcs
20	Gas spring ball head	95542	M8 D10	1
19	Sawdust guard	50014071		1
18	Washer	96085	M8	5
17	Washer	96064	M10	1
16	Lock screw	96187	M8x20	2
15	Lock screw	96411	M10x20	3
14	Lock screw	96186	M10x25	3
13	Hex socket screw	96002	M10x16	1
12	Hex screw	96165	M8x30	1
11	Hex screw	96161	M8x20	3
10	Hex screw	96138	M10x20	9
9	Washer	96061	A8	1
8	Washer	96049	A10	15
7	Hex screw	96124	M8x50	1
6	Hex nut	96196	M8	3
5	Locking nut	96068	M10	6
4	Locking nut	96222	M8	6
3	Log length limiter	50016021		1
2	Sawdust guard	50014072		1
1	External cover	50009978		1

1.14 Saw drive head (50010223 A)

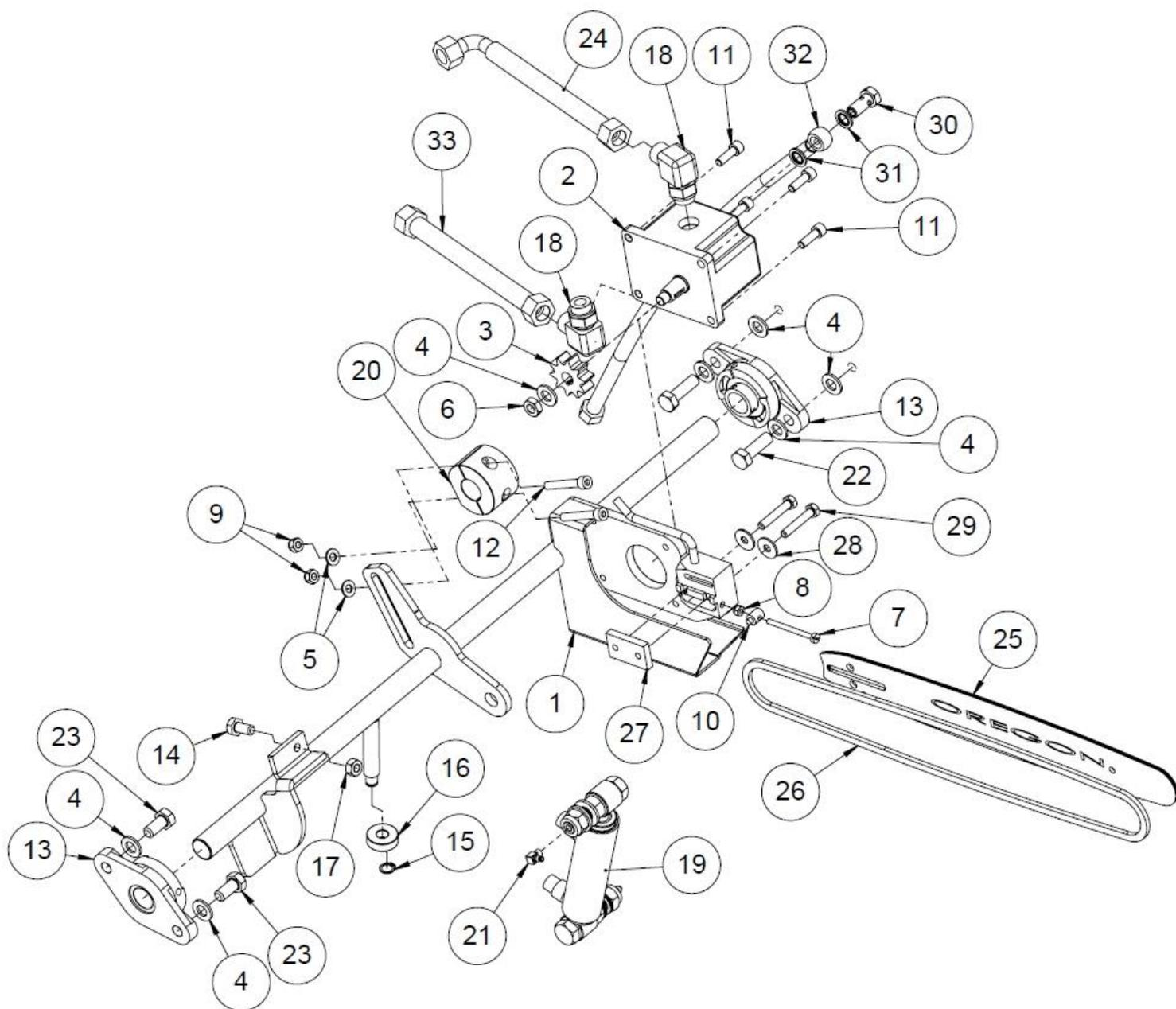

1.15 Saw drive head parts list

No.	Item	Part number	Dimensions	Pcs
1	Saw drive head	50010204		1
2	Saw motor	97657		1
3	Sprocket	37336	325-10	1
4	Washer	96058	A12	7
5	Washer	96061	A8	2
6	Hex screw	96206	M12	1
7	Screw	96266	M6x60	1
8	Locking nut	96221	M6	1
9	Locking nut	96222	M8	2
10	Clamping pin of cutting bar	10046		1
11	Hex screw	96035	M8x25	4
12	Hex screws	96308	M8x55	2
13	UC 205 Bearing	95318		2
14	Hex screws	96066	M10x20	1
15	Locking ring	96380	12	1
16	Bearing 6201	95567		1
17	Hex nut	96199	M10	1
18	Angle nipple 1/2"	97247		2
19	Saw cylinder	50016295		1
20	Support bearing	50010215		1
21	Lubrication nipple M8x1 90 GR	96275		1
22	Hex screw	96148	M12x40	2
23	Hex screws	96405	M12x25	2
24	Hydraulic hose	97058	1500mm	1
25	Cutting bar	95147	16 "	1
26	Saw chain	95668	68 links 0,325 1,5mm	1
27	Attachment plate	10044		1
28	Washer	96085	M8	2
29	Hex screw	96417	M8x45	2
30	Banjo- bolt	97480	1/4"	1
31	Usit- sealing	97211	1/4"	2
32	Hydraulic hose	97168	1400 x1/4"	1
33	Hydraulic hose	97109	1000 x 1/2"	1

1.16 Splitting mechanism (50029215 rev. A)

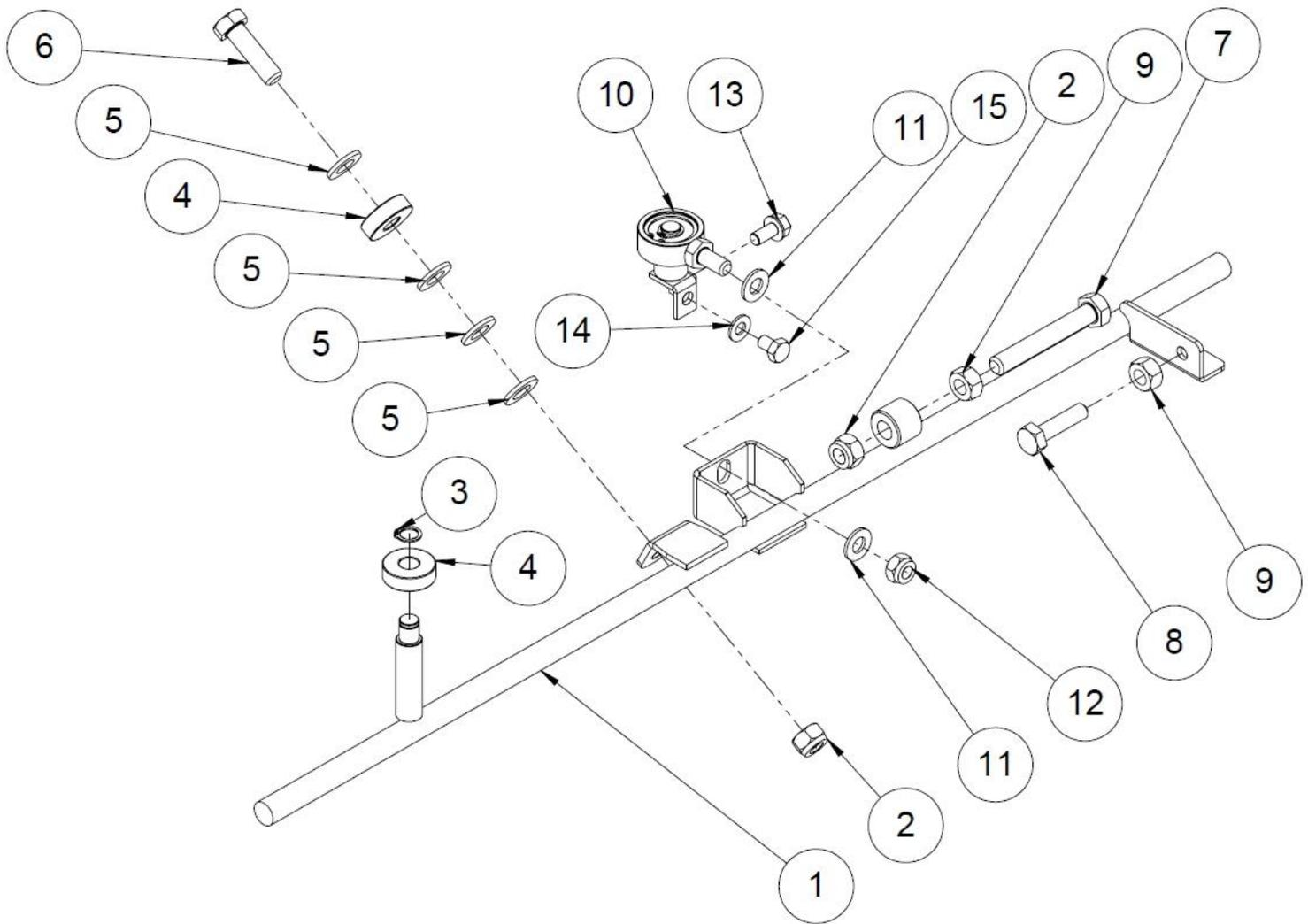

No.	Item	Part number	Dimensions	Pcs
15	Hex screw	96160	M8x12	1
14	Washer	96061	A8	1
13	Flange bolt M8x16	96172		1
12	Locking nut	96068	M10	1
11	Washer	96049	A10	2
10	Operating lever	50012229		1
9	Hex nut	96200	M12	2
8	Hex screw	96129_	M10x40	1
7	Hex screw	96151	M12x80	1
6	Hex screw	96148	M12x40	1
5	Washer	96058	A12	4
4	Bearing 6201	95567		2
3	Retaining ring	96380	12	1
2	Locking nut	96218	M12	2
1	Operating rod	50029216		1

1.17 Operating lever (50012229)

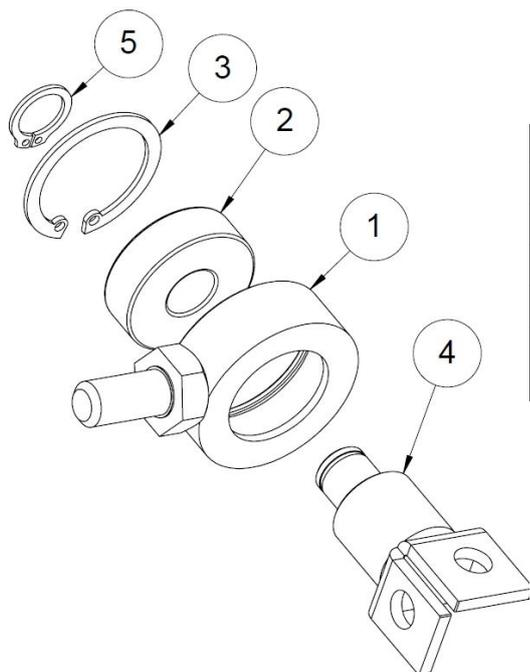

No.	Item	Part number	Dimensions	Pcs
5	Retaining ring	96380	12	1
4	Bearing fastener	50010885		1
3	Retaining ring	96390	32	1
2	Bearing 6201	95567		1
1	Operating rod for the valve	50012225		1

1.18 Splitting mechanism trigger (50012252)

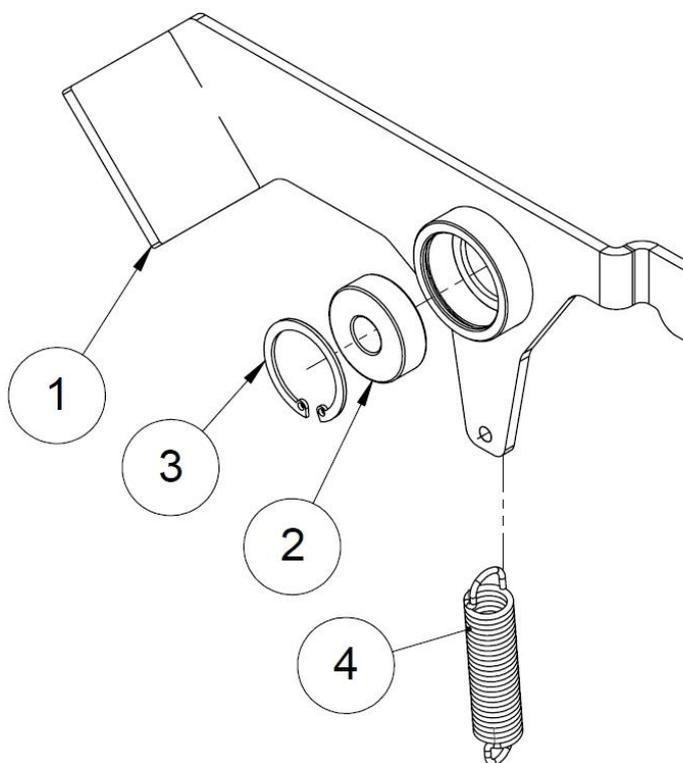

No.	Item	Part number	Pcs
4	Draw spring	95423	1
3	Retaining ring	96390	1
2	Bearing 6201	95567	1
1	Trigger lever	50010881	1

1.19 Splitting end guard (50013269)

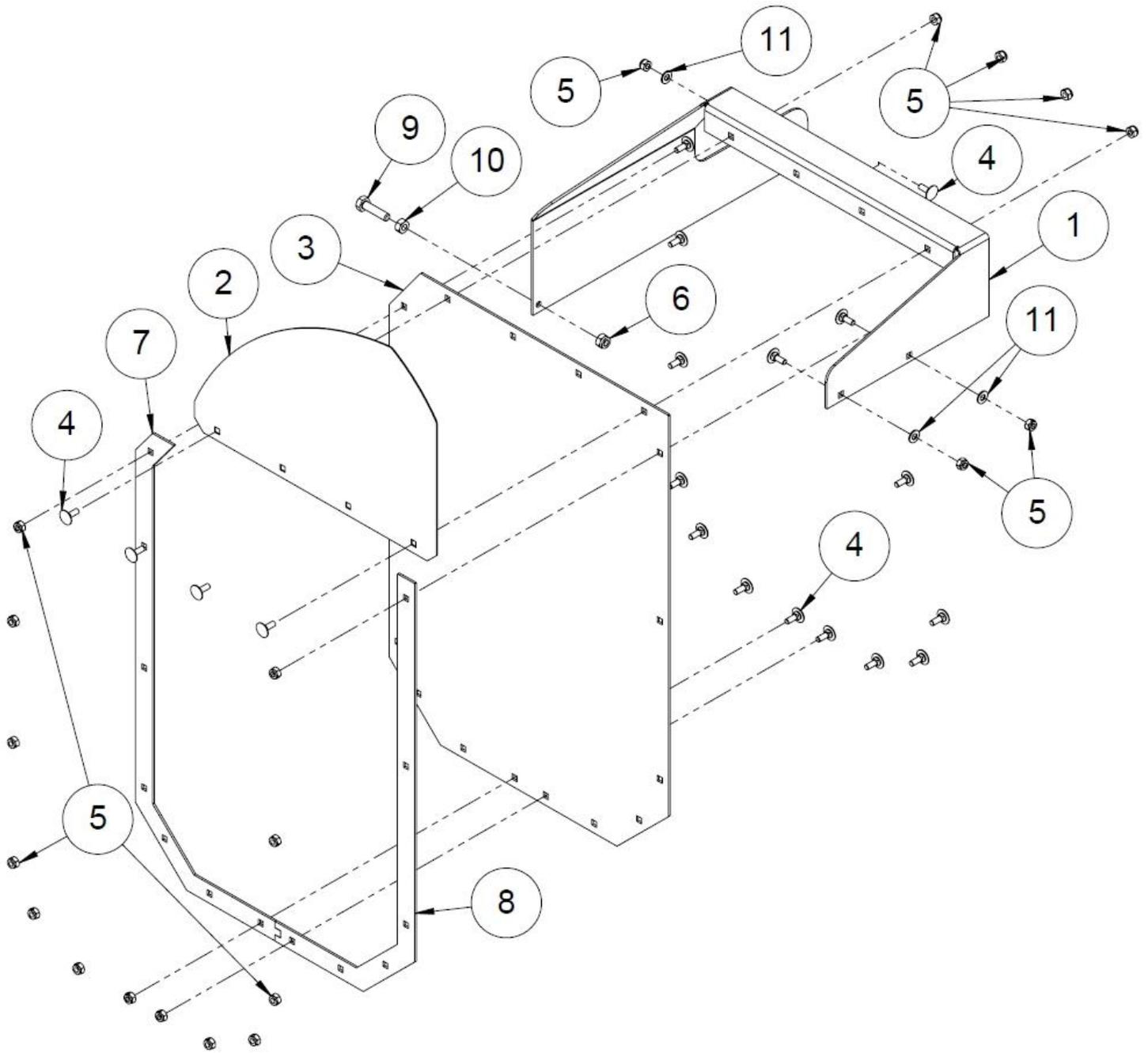

No.	Item	Part number	Dimensions	Pcs
11	Washer	96061	A8	3
10	Hex nut	96199	M10	1
9	Hex screw	96129_	M10x40	1
8	Protective strip	50015652	PL3 x	1
7	Protective mat strip	50015651	PL3 x	1
6	Locking nut	96068	M10	1
5	Locking nut	96222	M8	20
4	Lock screw	96187	M8x20	20
3	Protective strip	50013274	PL3 490x670	1
2	Upper cover for splitting	37614	PL1,50x295x425	1
1	Splitting guard fastener	50013268	PL3 x	1

1.20 Log measuring device (50016021 rev. C)

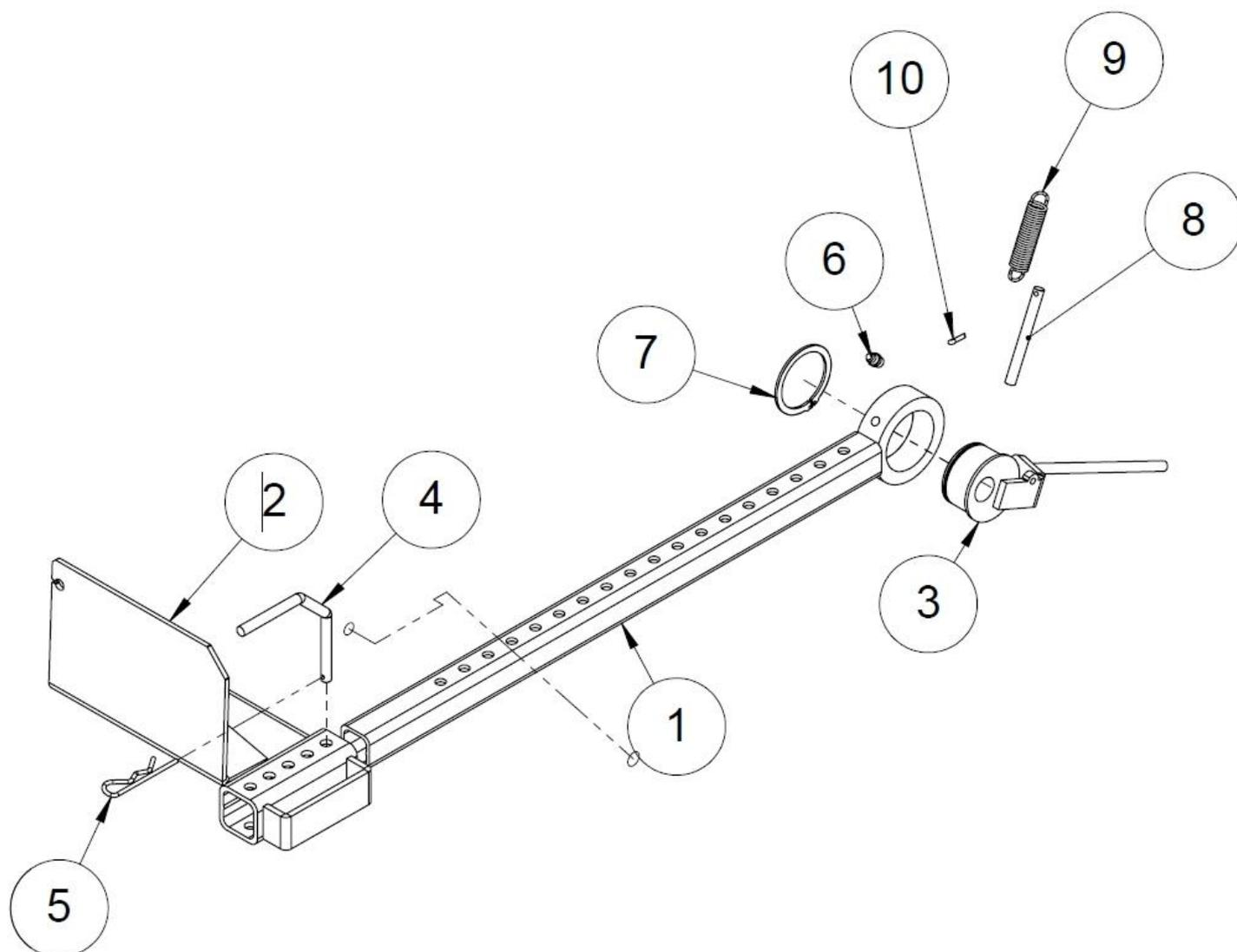

Part	Item	Part number	Pcs
10	Split pin	96245	1
9	Draw spring	95423	1
8	Stopper	50016016	1
7	Retaining ring	96046	1
6	Lubrication nipple M8X1	96276	1
5	Hitch pin	96208	1
4	Locking pin	10065	1
3	Eccentric flange	37562	1
2	Log length limiter	10063	1
1	Log length limiter pipe	10196	1

1.21 Splitting mechanism cylinder (50016295)

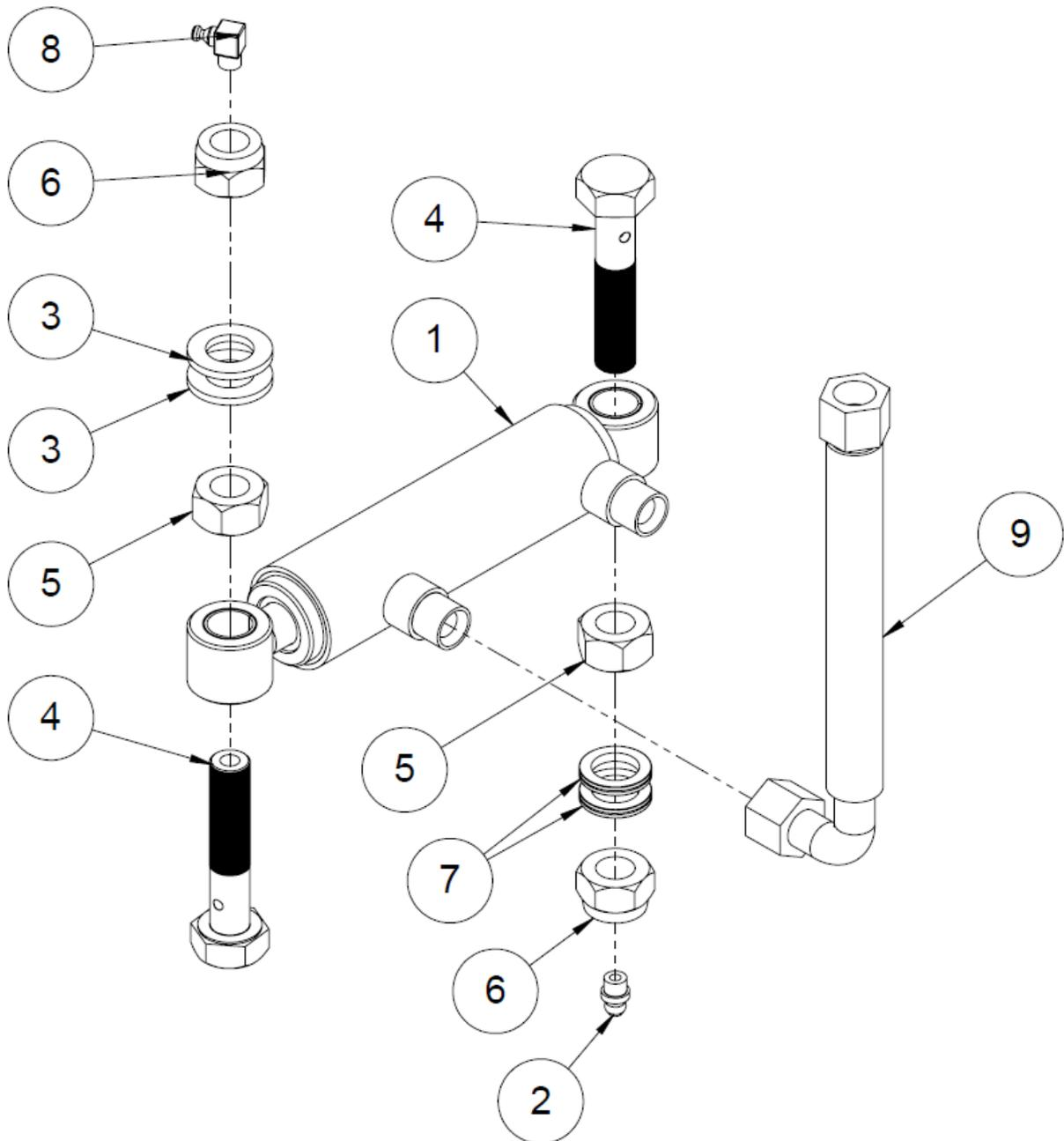

No.	Item	Part number	Dimensions	Pcs
9	Hydraulic hose	97008	3/8" x 700	1
8	Lubrication nipple	96275	M8x1 90 GR	1
7	Lock washer M16	96412	M16 Nordlock	2
6	Locking nut	96219	M16	2
5	Hex nut	96195	M16	2
4	Hex screw	37550	M16	2
3	Washer	96059	A16	2
2	Lubrication nipple	96276	M8X1	1
1	Hydraulic cylinder	10242		1

1.22 Saw chain lubrication pump (50016796)

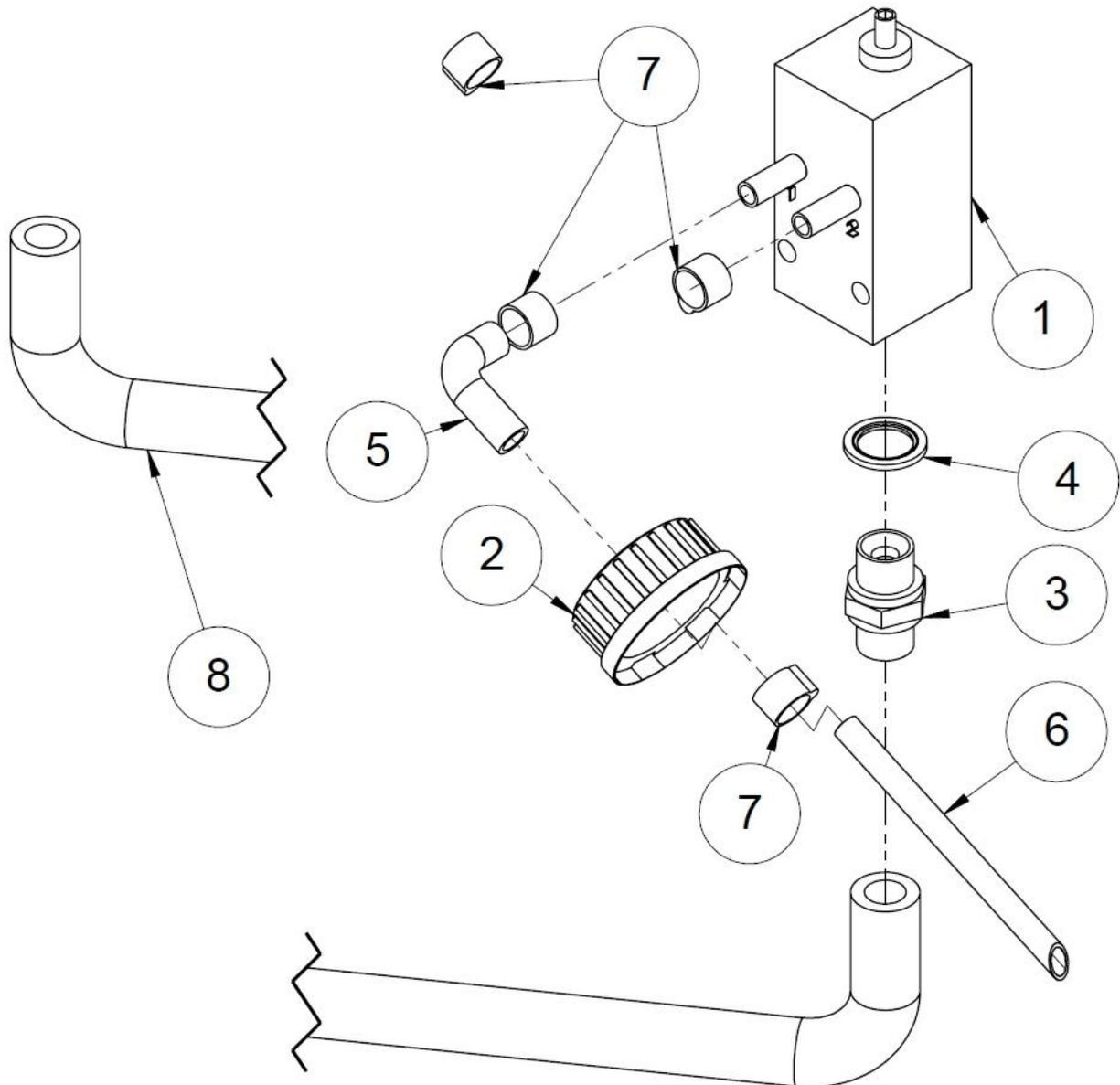

No.	Item	Part number	Dimensions	Pcs
	Service part kit for oil injector: springs+gaskets+connectors	97940		
8	Hose	96167	1,900 x 1/4"	1
7	Hose binder 10	96174		4
6	Saw chain oil suction pipe	50014496	Ø8x1 L=100	1
5	ToppFlex PUR hose 8/11	95606	1 x 700 mm and 1 x 900 mm	2
4	3/8" USIT	97212		1
3	Choke nipple 1 mm, straight	97276	3/8", 3/8"	1
2	Oil cap	95644		1
1	Saw chain oil injector	97848		1

1.23 In-feed conveyor drive roller assembly (50017534)

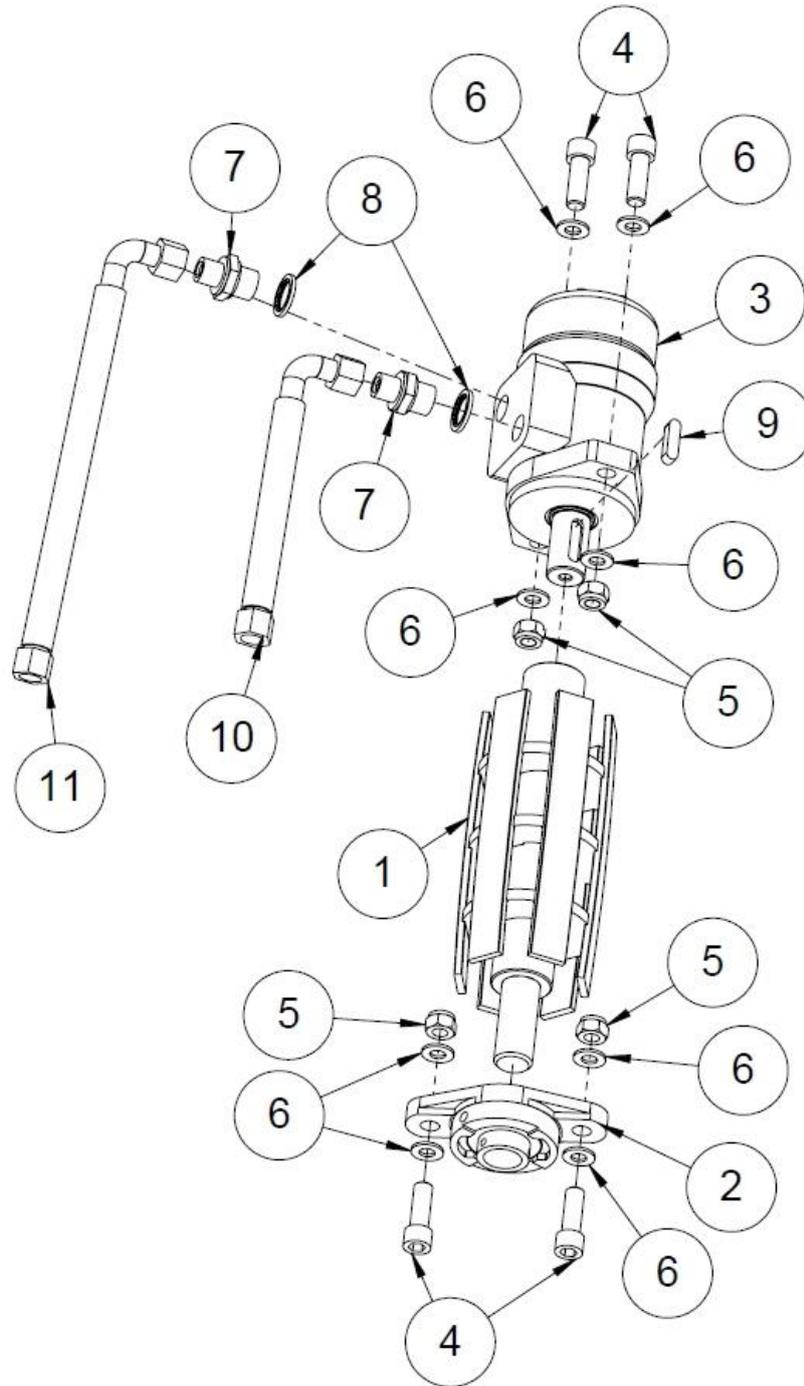

No.	Item	Part number	Dimensions	Pcs
11	Hydraulic hose	97045	1,600 x 3/8"	1
10	Hydraulic hose	97008	700 x 3/8"	1
9	Wedge	97371		1
8	USIT 1/2"	97213		2
7	Double nipple, straight	97203	3/8" x 1/2"	2
6	Washer	96049	A10	8
5	Locking nut	96218	M12	4
4	Hex socket screw	96413	M12x35	4
3	Hydraulic motor	97308	08/2018-->	1
2	Bearing, UC 205	95318		1
1	In-feed conveyor drive roller	50000467		1

1.24 Out-feed conveyor turning device (50017575)

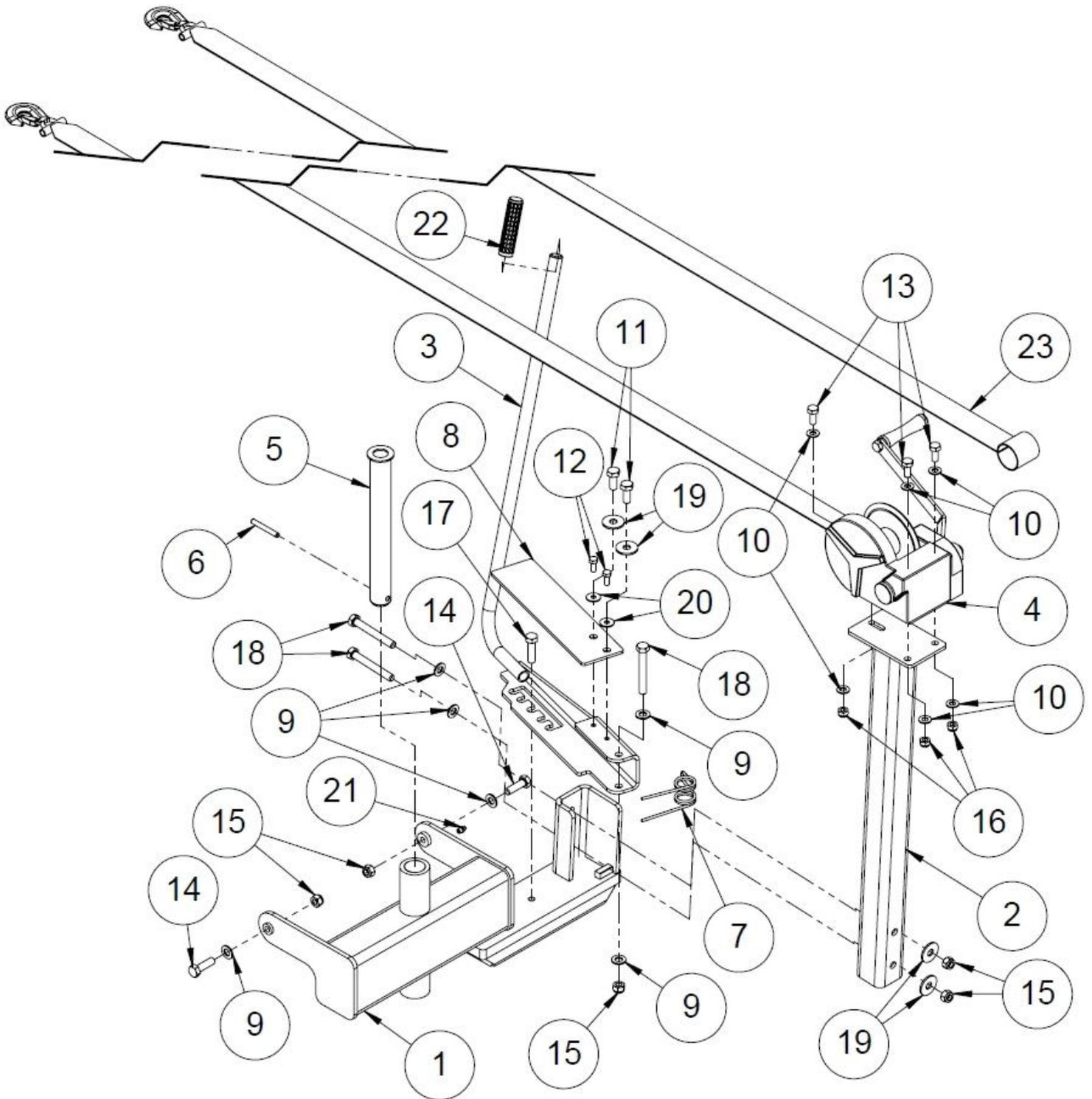

1.25 Turning device (50017575) parts list

No.	Item	Part number	Dimensions	Pcs
23	Winch strap with hook	95068		1
22	Handle	95034		1
21	Lubrication nipple	96276	M8x1	1
20	Washer	96085	M8 3/2015-->	2
19	Washer	96340	M12	4
18	Hex screw	96111	M12x90	3
17	Hex screw	96107	M12x45	1
16	Locking nut	96068	M10	3
15	Locking nut	96218	M12	5
14	Hex screw	96148	M12x40	2
13	Hex screw	96139	M10x25	3
12	Hex screw	96161	M8x20 3/2015-->	2
11	Hex screw	96146	M12x30	2
10	Washer	96049	A10	6
9	Washer	96058	A12	6
8	Splinter guard	50012933		1
7	Double torsion spring	95432		1
6	Spring pin	96079	8x60	1
5	Turning device pin	50006392		1
4	Out-feed conveyor winch complete	37151		1
3	Out-feed conveyor stopper	50012586		1
2	Winch fastening pipe	10825		1
1	Out-feed conveyor turning device	10600		1

1.26 Connection block

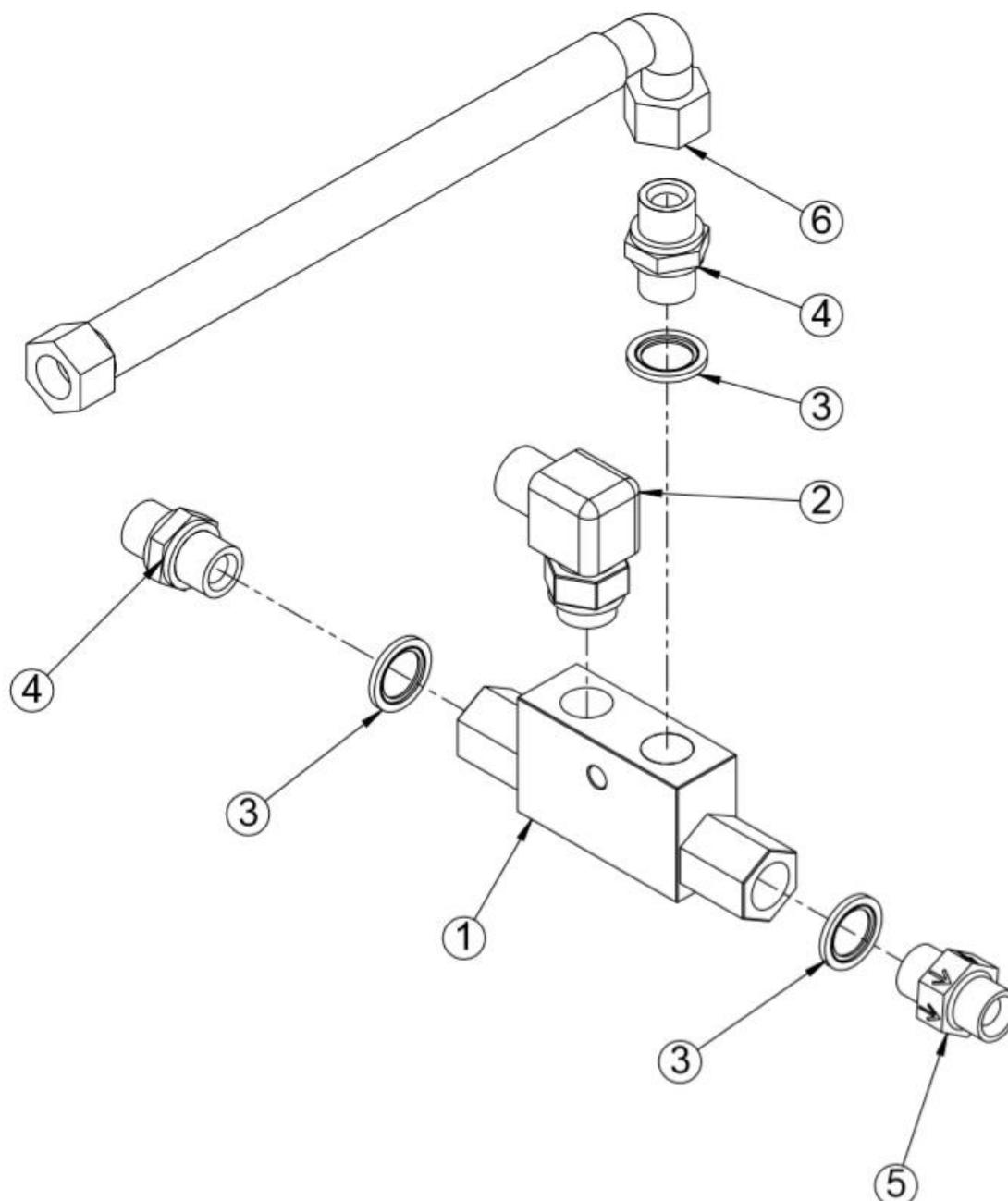

Nr.	Name	Part number	Dimension	Pc.
1	Connection block, Falcon	97931		1
2	Corner nipple 1/2"	97247		1
3	Usit 1/2"	97213		3
4	Double nipple 1/2" x 1/2"	97204		2
5	Double nipple, back valve 1/2"	97653		1
6	Hydraulic hose	97108	1/2"x650	1

1.27 Connection block 2

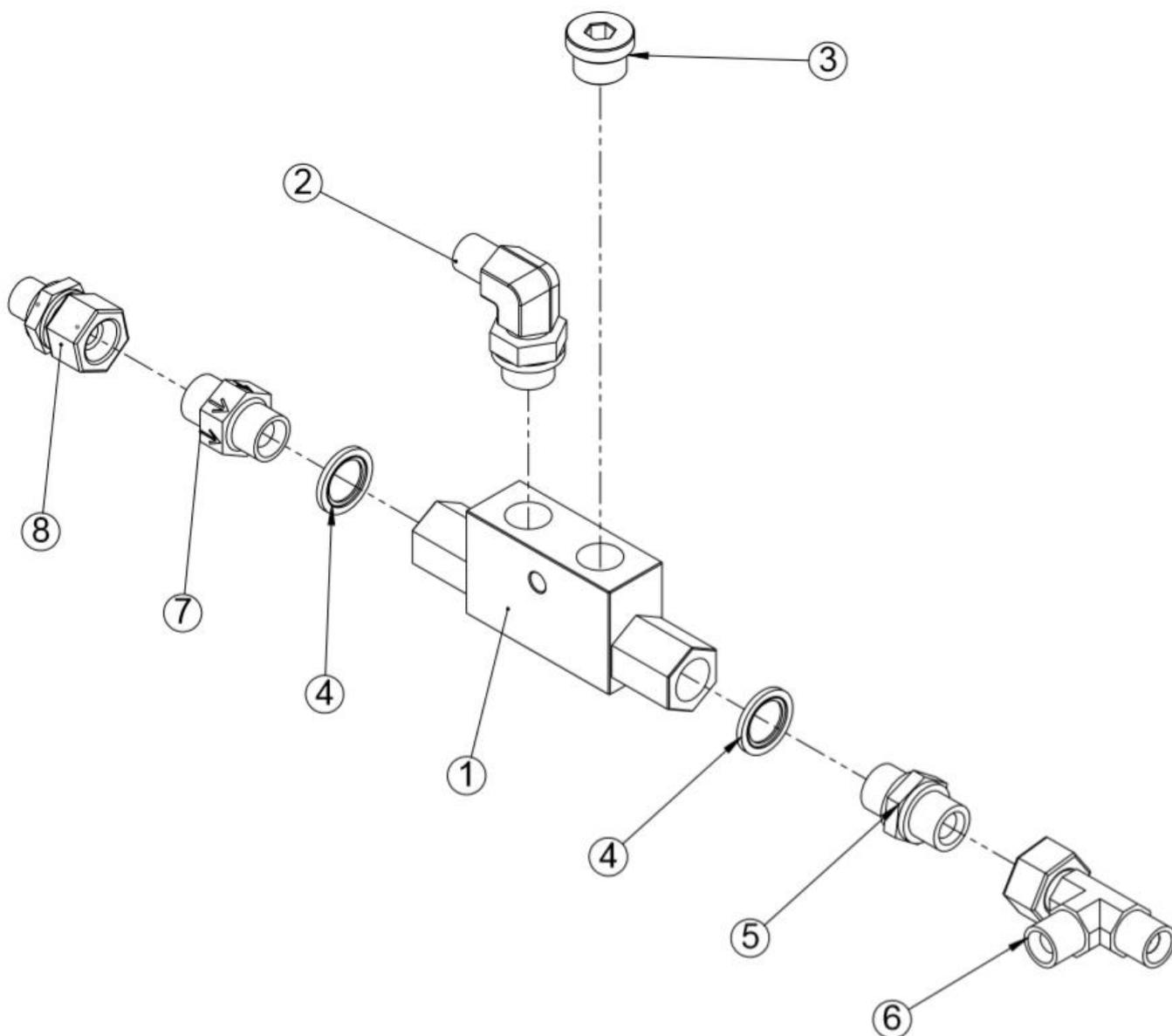

Nr.	Name	Part Number	Pc.
1	Connector block	97931	1
2	Corner nipple 1/2"x3/8"	97610	1
3	Plug 1/2"	97261	1
4	Usit 1/2"	97213	2
5	Double nipple 1/2" x 1/2"	97204	1
6	L-connector 1/2"	97228	1
7	Double nipple, back valve 1/2"	97653	1
8	Connection nipple 3/8"x1/2"	97218	1

1.28 Control valve (50018479)

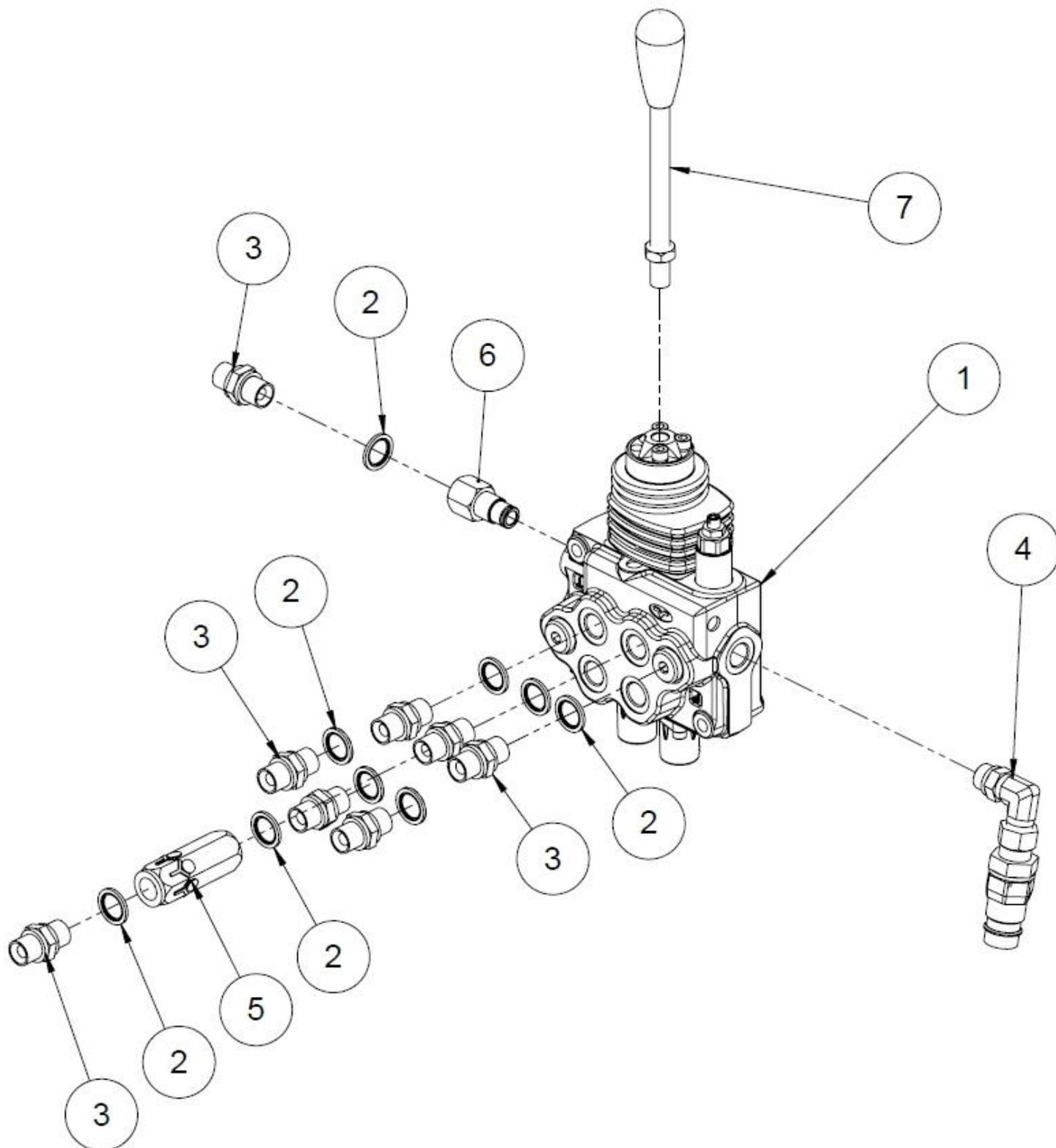

No.	Item	Part number	Pcs
7	AL08/m12*150 lever	97425	1
6	Series connection fitting 3/8"	97880	1
5	Check valve 3/8" 2 bar	97618	1
4	Quick coupler kit	37650	1
3	Double nipple 3/8" x 3/8"	97202	8
2	USIT 3/8"	97212	9
1	Valve (lightened springs)	50017711	1

1.29 Flow control valve (50016299)

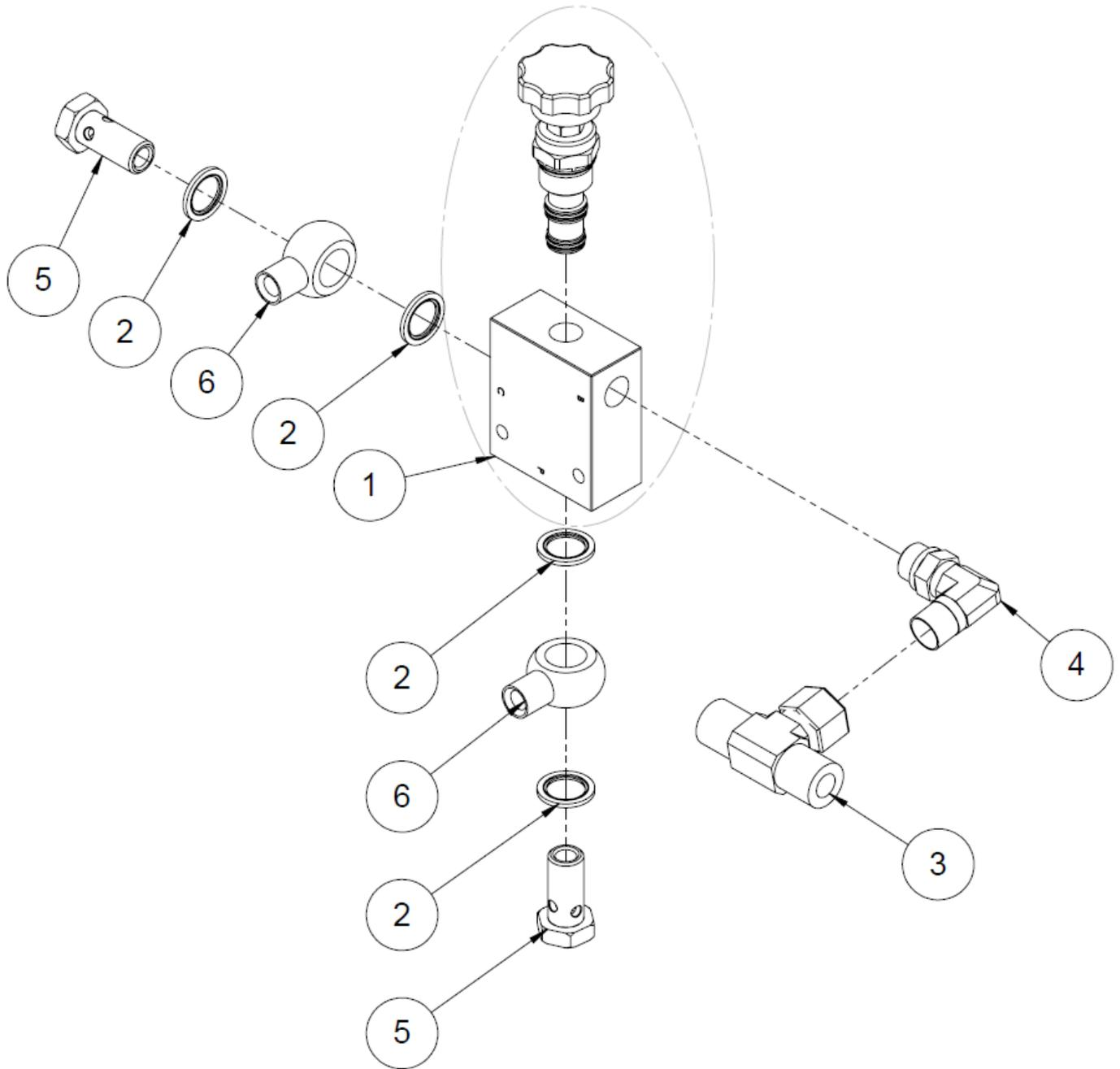

No.	Item	Part number	Dimensions	Pcs
6	Directional elbow nipple	97250	3/8"	1
5	Adjustable T connector	97230	3/8"	1
4	Banjo connector	97273	3/8"	2
3	Banjo connector	97258	3/8"	2
2	USIT	97212	3/8"	4
1	Adjuster	97524	12/2018-->	1

1.30 Auxiliary device control valve assembly (35202, accessory)

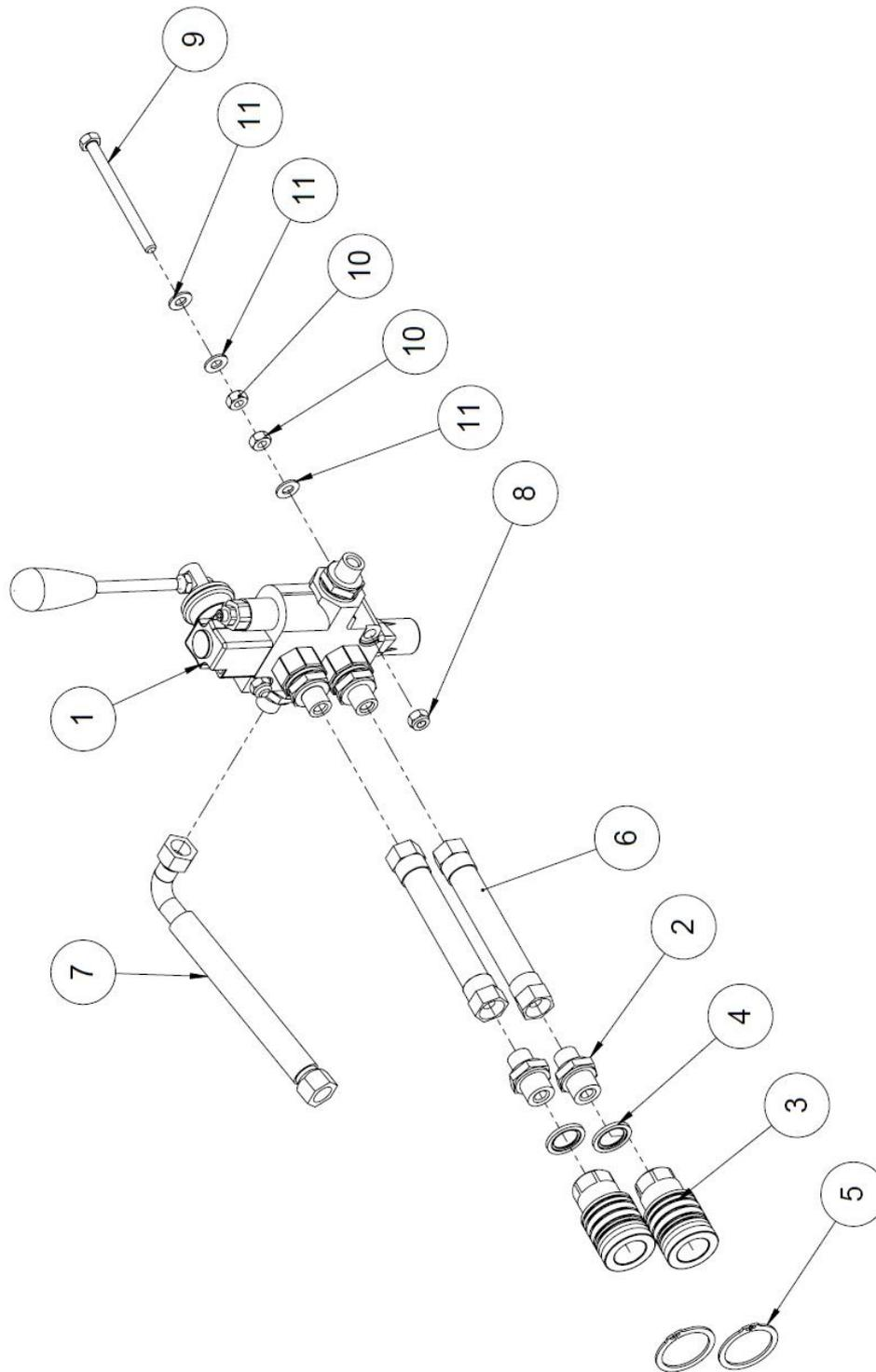

No.	Item	Part number	Dimensions	Pcs
11	Washer	96061	A8	6
10	Hex nut	96196	M8	4
9	Hex screw	96414	M8x100	2
8	Locking nut	96222	M8	2
7	Hydraulic hose	97010	3/8" x 400	1
6	Hydraulic hose	97018	3/8" x 400	2
5	Retaining ring	96371	38	4
4	USIT 1/2"	97213		2
3	Quick coupler female 1/2"	97388		2
2	Double nipple 3/8" x 1/2"	97203		2
1	Auxiliary valve	37638		1

1.31 Upper section of the out-feed conveyor

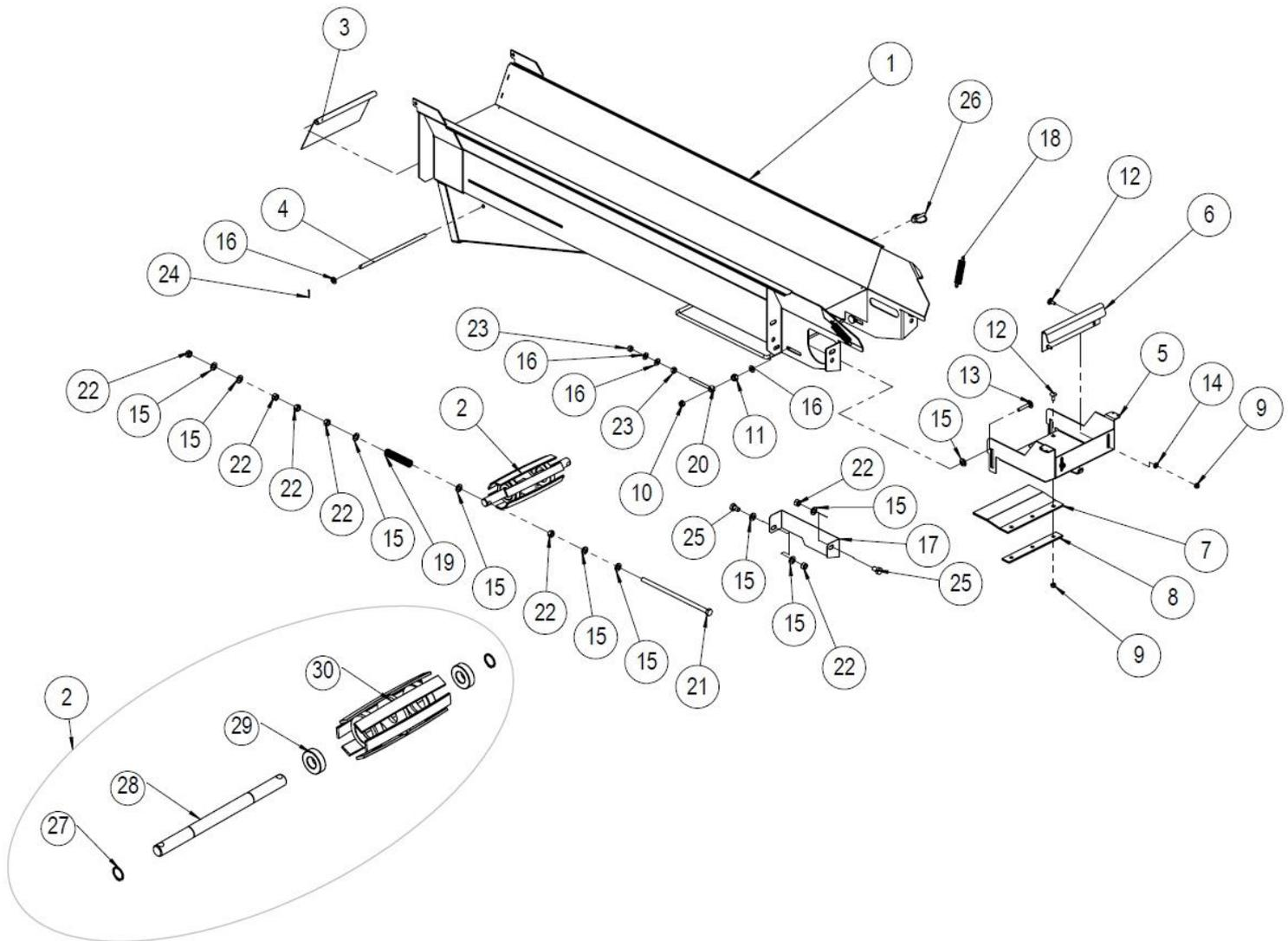

No.	Part number	Name	Pcs
1	10832	Upper section frame	1
2	10132	Upper roller of the conveyor	1
3	37414	Protective plate	1
4	37411	Link rod	1
5	50028549	Debris separator	1
6	37412	Lip plate	1
7	10864	Debris separator rubber	1
8	10136	Connection plate for the belt	1
9	96222	Locking nut DIN 985 M8	5
10	96068	Locking nut DIN 985 M10	2
11	96218	Locking nut DIN 985 M12	2
12	96187	Locking screw DIN 603 M8x20	5
13	96312	Locking screw DIN 603 M10x50	2
14	96061	Washer DIN 125 A8	2

15	96058	Washer DIN 125 A12	17
16	96049	Washer DIN 125 A10	8
17	10858	Protective plate for the roller	1
18	95390	Draw spring 2x20x100	2
19	95722	Pressure spring 5x24x100	2
20	96338	Eye bolt DIN 444 M10x90	2
21	96355	Hex screw DIN 933 M12x280	2
22	96200	Hex nut DIN 934 M12	12
23	96199	Hex nut DIN 934 M10	4
24	96244	Split pin DIN 94 2.5x20	2
25	96144	Hex screw DIN 933 M12x20	2
26	96242	Ring pin 8 mm	1
27	96042	Retaining ring DIN 471 25	2
28	10132b	Shaft	1
29	95050	Bearing 6205	2
30	50000211	Upper roller	1

1.32 Out-feed conveyor belt (10317)

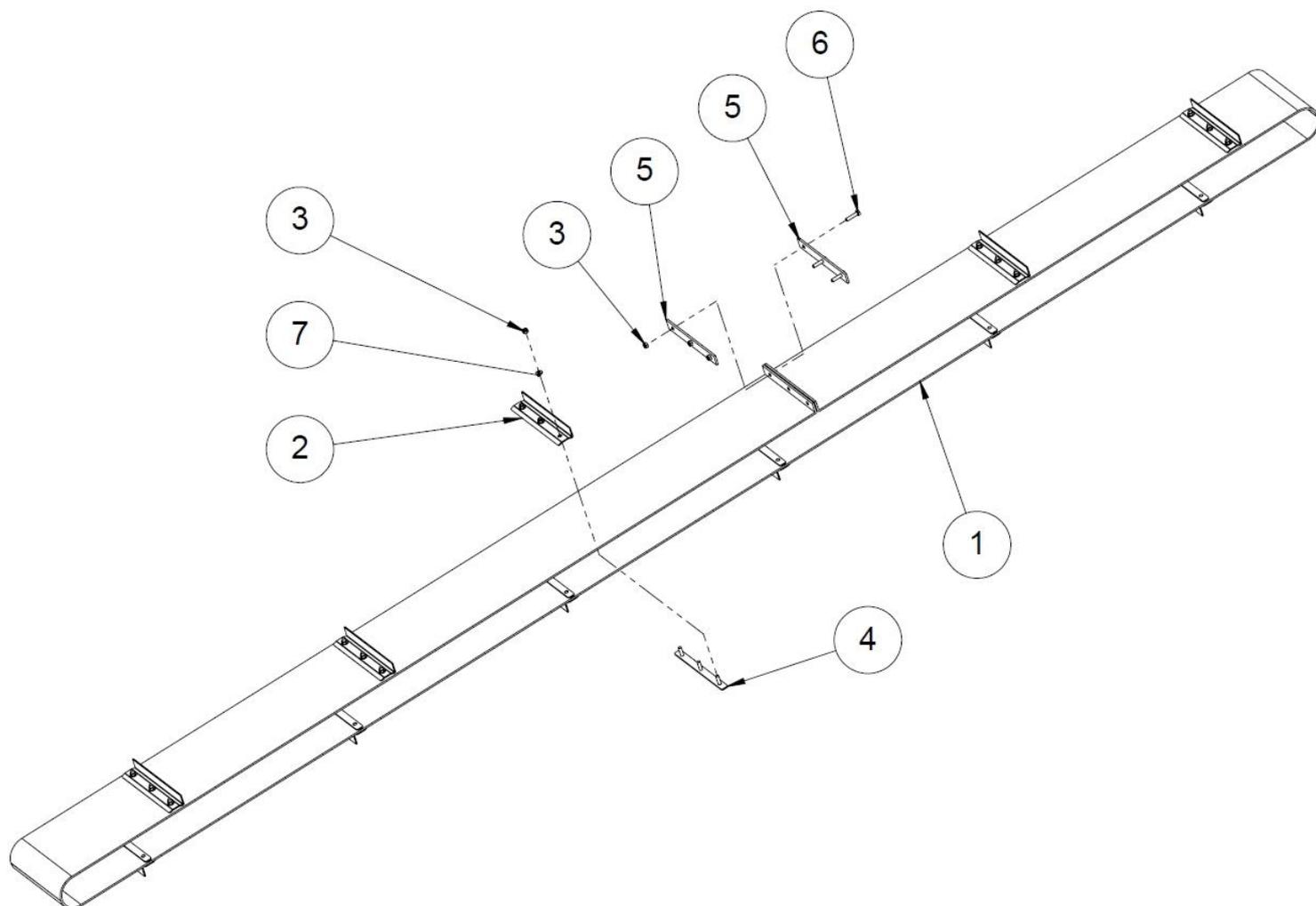

No.	Part number	Name	Pcs
1	95126	Conveyor belt	1
2	10135	Cleat	11
3	96222	Locking nut DIN 985 M8	36
4	10863	Plate fastening	11
5	10136	Connection plate for the belt	2
6	96166	Hex screw DIN 933 M8x35	3
7	96061	Washer DIN 125 A8	33

1.33 Lower section of the out-feed conveyor

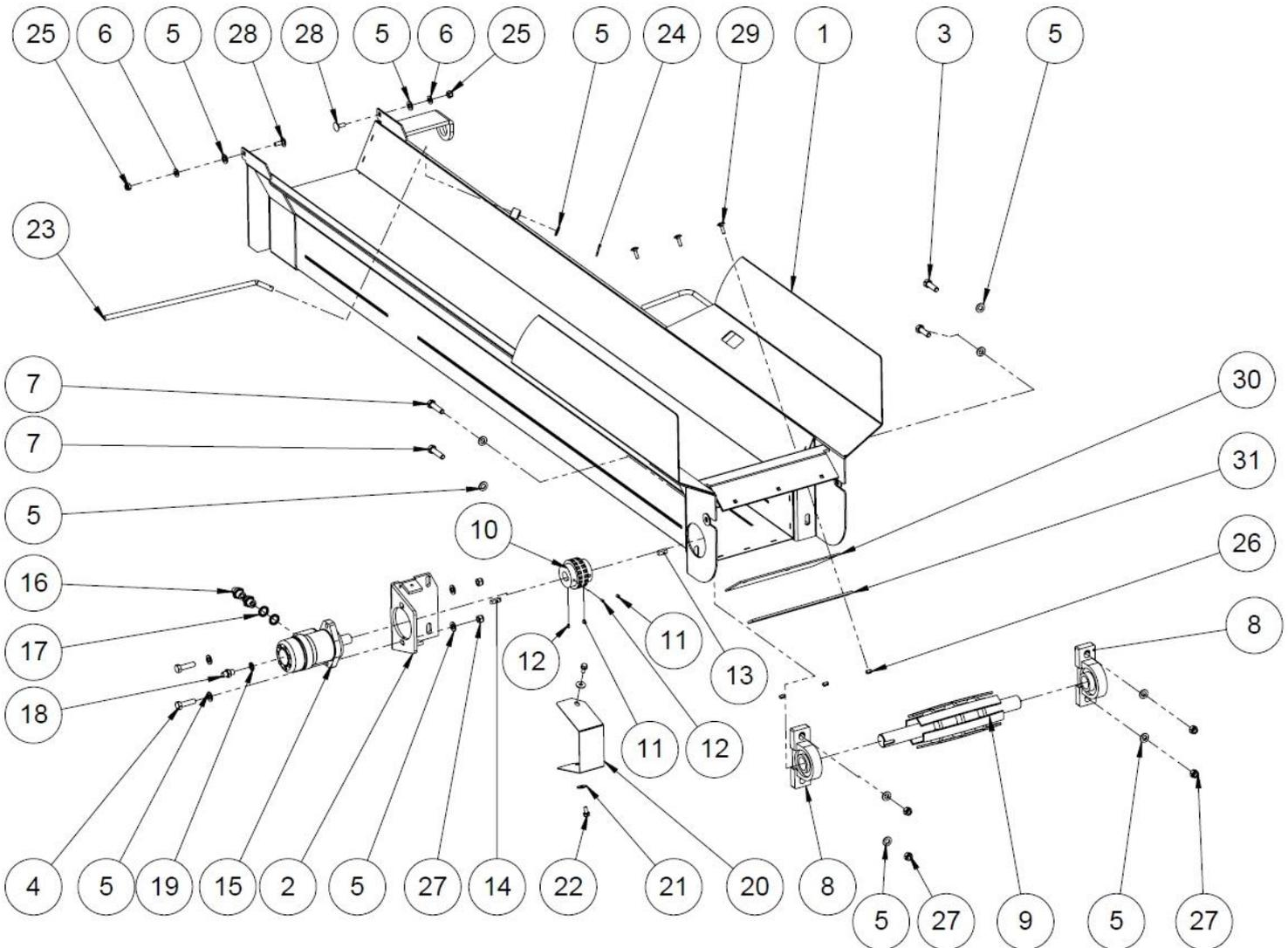

No.	Part number	Name	Pcs
1	10833	Lower frame of the conveyor	1
2	50015466	Motor fastening plate	1
3	96148	Hex screw DIN M12x40	2
4	96149	Hex screw DIN M12x45	2
5	96058	Washer DIN A12	15
6	96049	Washer DIN A10	2
7	96108	Hex screw DIN M12x50	2
8	95058	Bearing unit	2
9	50015676	Drive roller	1
10	95448	Chain coupling	1
11	96228	Socket set screw M8x8	2
12	96362	Socket set screw M6x8	2
13	47642	Wedge	1
14	97371	Wedge	1
15	97334	Hydraulic motor OMP-50	1

16	97203	Double nipple, straight 3/8" x 1/2"	2
17	97213	USIT 1/2"	2
18	97200	Double nipple, straight 1/4" x 1/4"	1
19	97211	USIT 1/4"	1
20	47654	Guard	1
21	96085	Washer M8	2
22	96172	Flange bolt M8x16	2
23	10819	Conveyor belt holder	1
24	96246	Split pin 3.2x32	1
25	96068	Locking nut M10	2
26	96222	Locking nut M8	3
27	96218	Locking nut M12	6
28	96186	Locking screw M10x25	2
29	96191	Locking screw M8x25	3
30	95130	Conveyor rubber flap	1
31	61172	Conveyor rubber flap fastening rod	1

1.34 Hydraulic pump + multiplier gearbox (50008181_B)

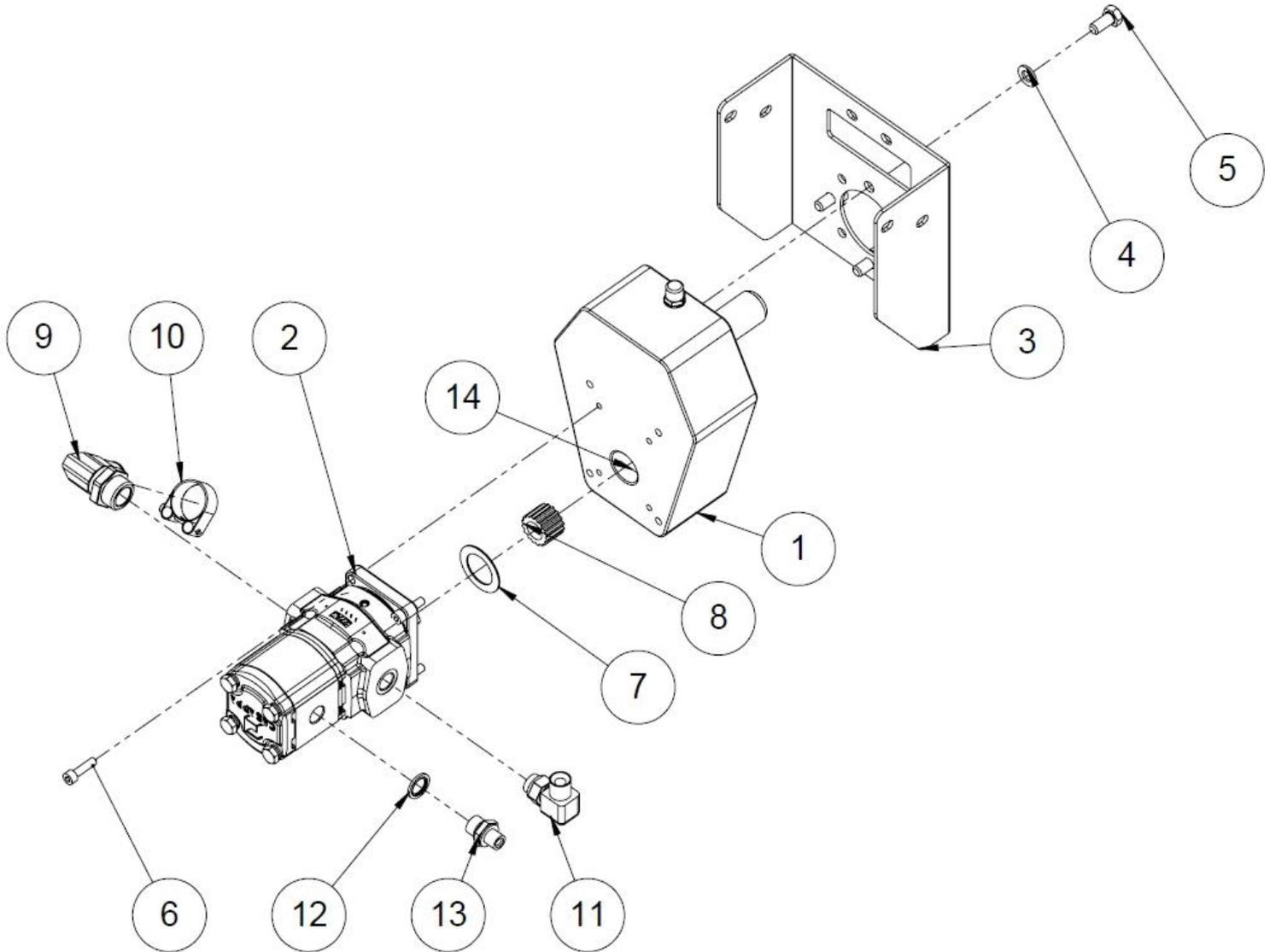

No.	Item	Part number	Dimensions	Pcs
14	Transmission oil	95514	80"/90 0.3 l	1
13	Double nipple	97203	3/8" x 1/2"	1
12	USIT	97213	1/2"	1
11	Directional elbow nipple	97247	1/2"	1
10	Hose clamp	97850		1
9	Suction connector	97849	1"/32mm	1
8	Boron bushing	95608		1
7	Shim	50008329		1
6	Hex socket screw	96341	M8x30	4
5	Hex screw	96405	M12x25	4
4	Washer	96058	A12	4
3	Gear mounting	50010155		1
2	Hydraulic pump	97325	08/2018-->	1
1	Multiplier gear	95652		1

1.35 Splitting cylinder (50025390)

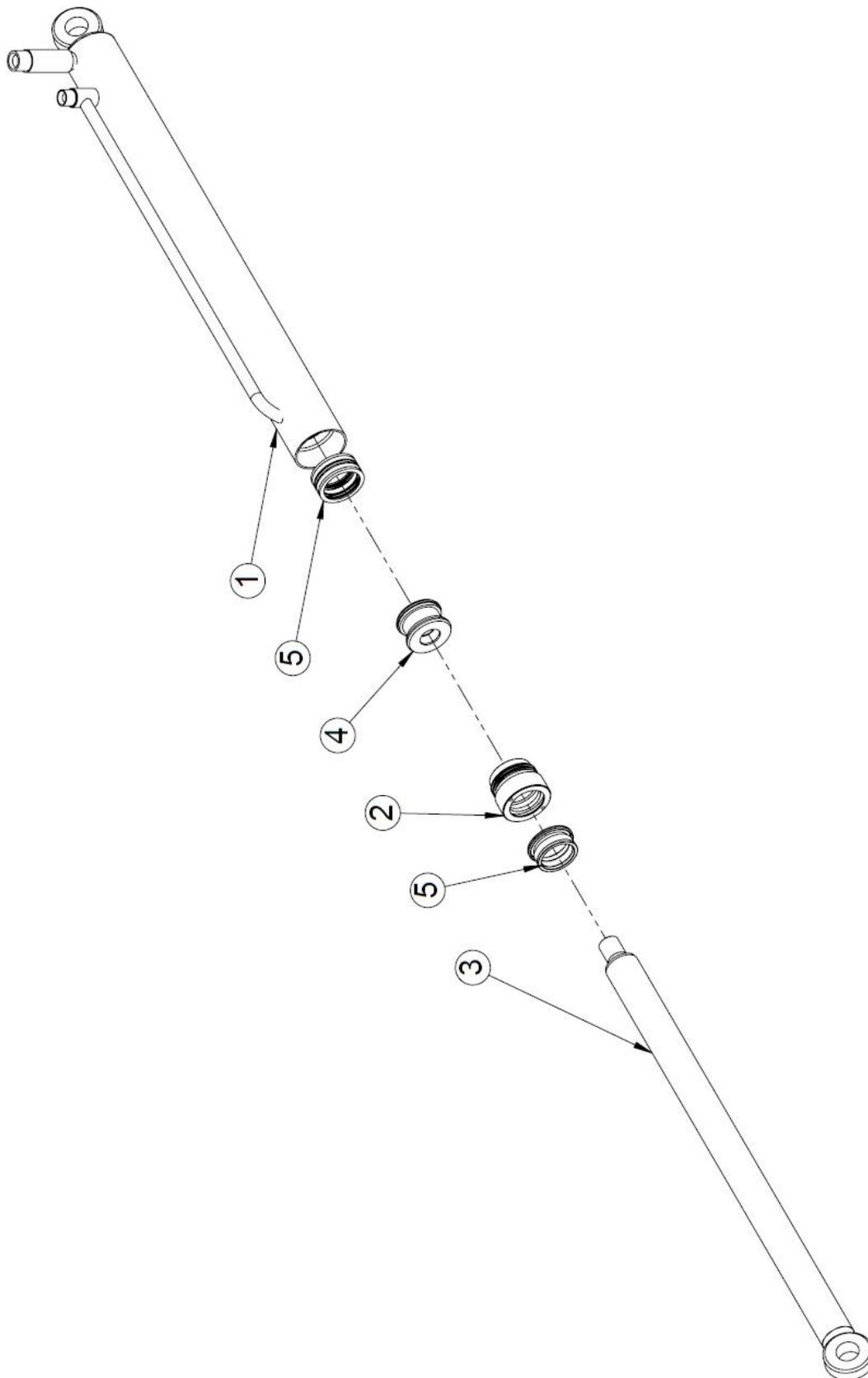

No.	Item	Part number	Pcs
5	Seal kit D73 63-45	97296	1
4	Plunger Ø63	10664	1
3	Cylinder rod D45	50025388	1
2	Arm control Ø73,63-45	10665	1
1	Cylinder tube 73/63	50025391	1

1.36 Stroke limiter valve (50033698)

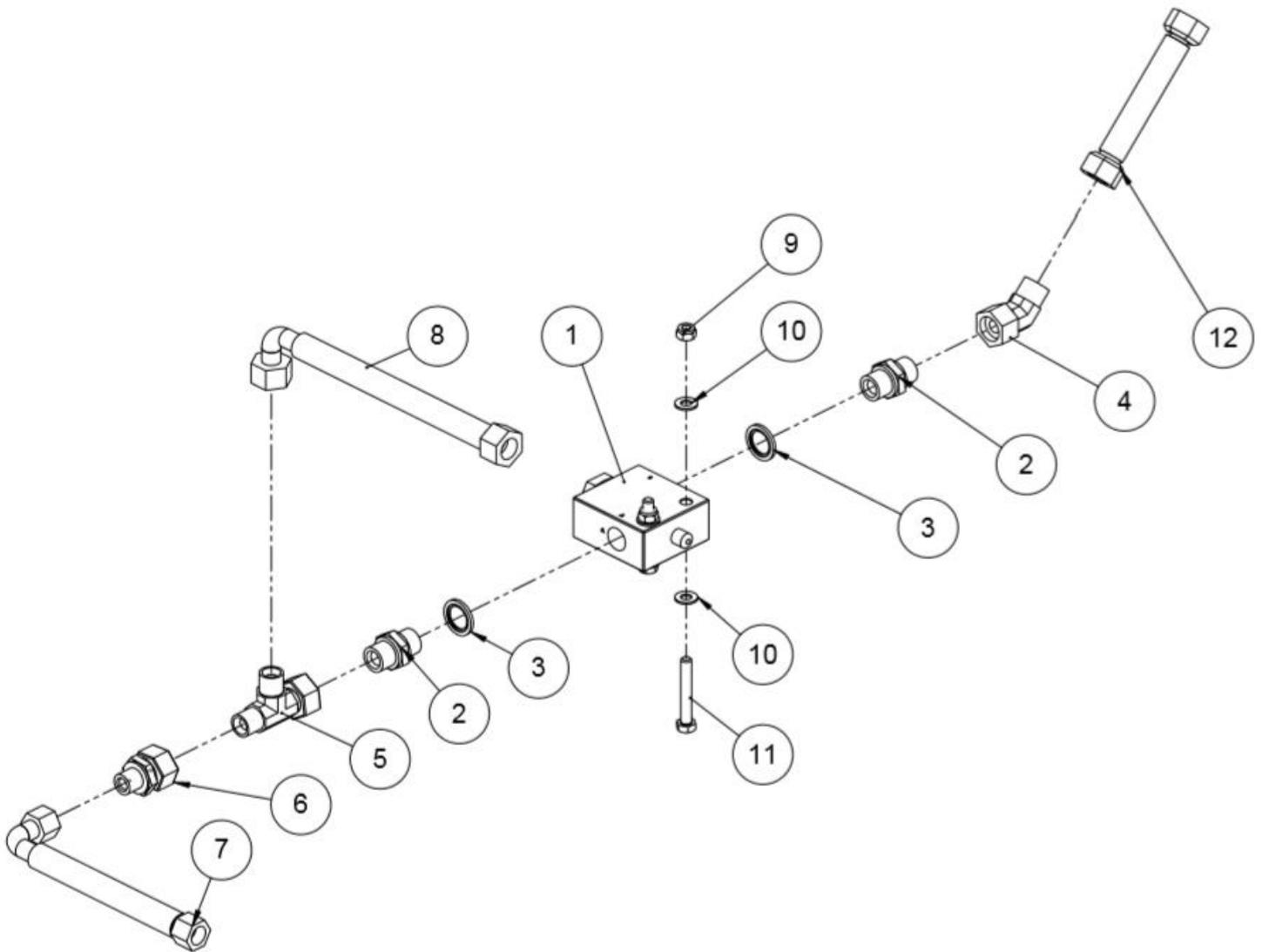

Nr.	Name	Part number	Dimension	pcs.
12	Hydraulic hose	97099	1/2"x650	1
11	Hex. screw	96125	M8x55	2
10	Washer	96061	A8	4
9	Locking nut	96222	M8	2
8	Hydarulic hose	97058	1/2"x1500	1
7	Hydraulic hose	97008	3/8"x700	1
6	Connection nipple 3/8" uk x 1/2" sk	97218		1
5	L-connector 1/2"	97228		1
4	Corner nipple 45 ° 1/2" uk/sk	97249		1
3	Usit 1/2"	97213		2
2	Double nipple 1/2" x 1/2"	97204		2
1	Stroke limiter valve	97635		1

1.37 Control panel (50018471)

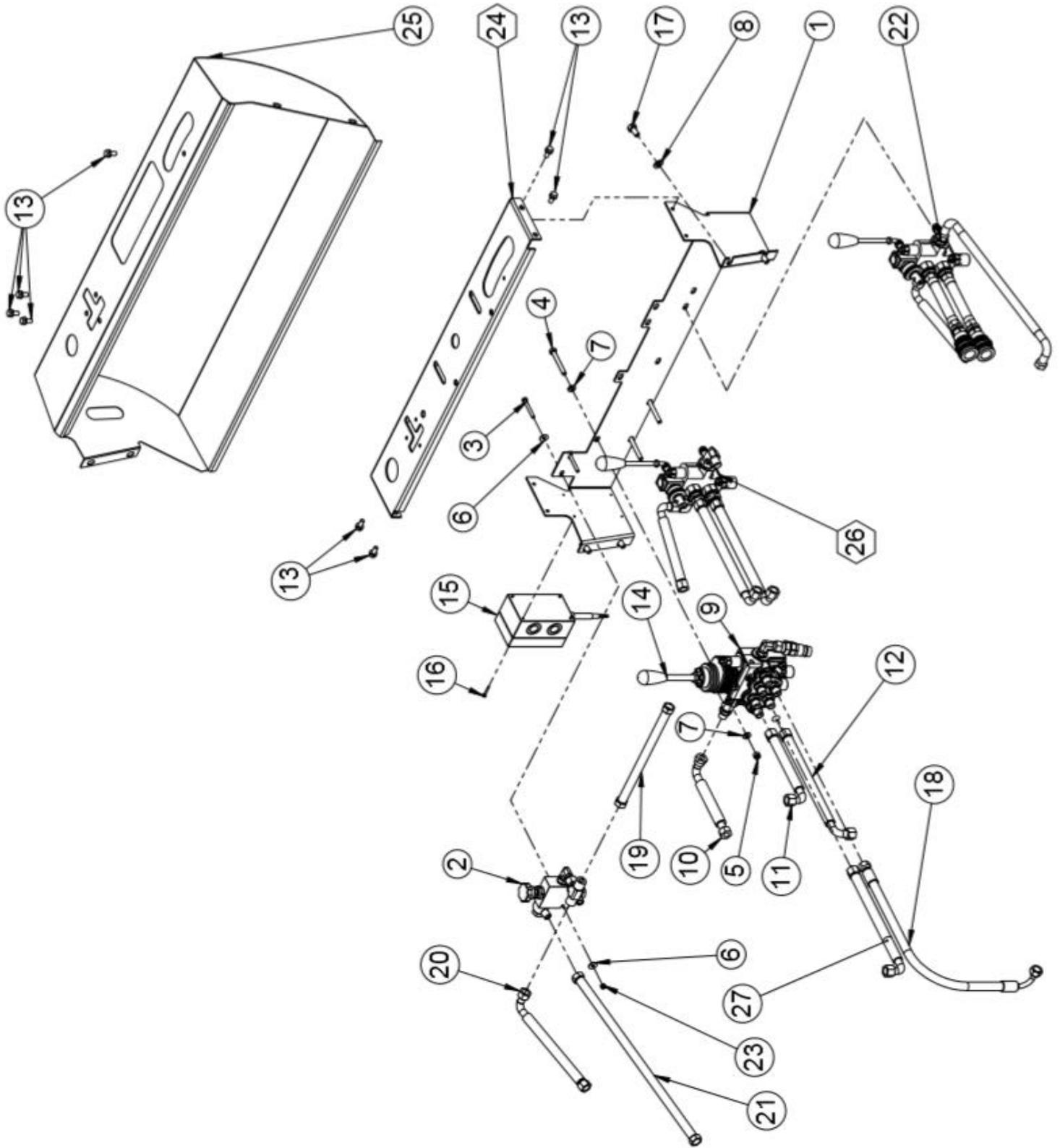

Nr.	Name	Part number	Dimension	Pc.
26	Valve packet	50040806		1
25	Control panel	50011375		1
24	Valve rack cover	50012923		1
23	Locking nut	96221		2
22	Extra valve	50016297		1
21	Hydraulichose	97199	3/8"x2000	1
20	Hydraulic hose	97034	3/8"x2000	1
19	Hydraulic hose	97007	3/8"x800	1
18	Hydraulic hose	97025	3/8"x1000	1
17	Hex. screw	96138	M10x20	4
16	Screw	96261	M4x25 -Z	4
15	Starter	37648		1
14	Lever	97425		1
13	Flame bolt	96172		4
12	Hydraulic hose	97045	3/8"x1600	1
11	Hydraulic hose	97008	3/8"x700	1
10	Hydraulic hose	97131	3/8"x1200	1
9	Control valve	50018479		1
8	Washer	96049	A10	4
7	Washer	96061	A8	8
6	Washer	96084	M6	2
5	Locking nut	96222	M8	3
4	Hex. Screw	96127	M8x65	3
3	Hex. Screw	96119	M6x50	2
2	Flow control valve	50016299		1
1	Valve rack	50012855		1

1.38 Splitting valve assembly (50009823 Rev. B)

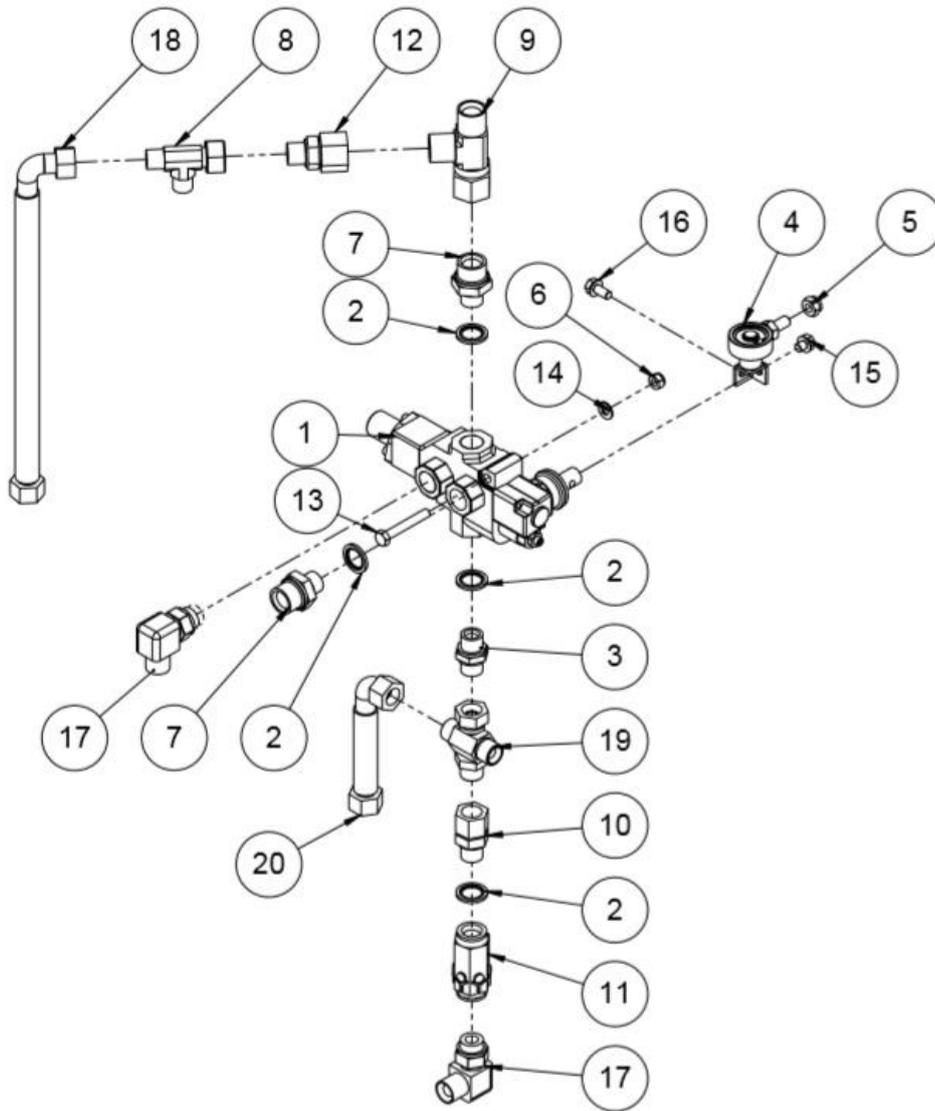

Nro	Nimi	Osanumero	Mitat	Kpl
20	Hydraulic hose	97119	1/2"x900	1
19	Connector 1/2"	97753		1
18	Hydraulic hose	97014	1/2"x750	1
17	Corner nipple 1/2"	97247		2
16	Flame bolt M8x16	96172		1
15	Flame bolt M8x8	96552		1
14	Washer	96061	A8	2
13	Hex. screw	96125	M8x55	2
12	connection nipple 1 1/2" uk x 3/4" sk	97221		1
11	Back valve 1/2" 0,5 bar	97252		1
10	connection nipple 1/2" uk x sk	97216		1
9	L-connection 3/4"	97235		1
8	L-connection 1/2"	97228		1
7	Double nipple 1/2" x 3/4"	97205		2
6	Locking nut	96222	M8	2
5	Locking nut	96068	M10	1
4	Lever	50012229		1
3	Double nipple 1/2" x 1/2"	97204		1
2	Usit 1/2"	97213		4
1	Splitting valve	97822		1

1.39 Saw valve assembly (50016293)

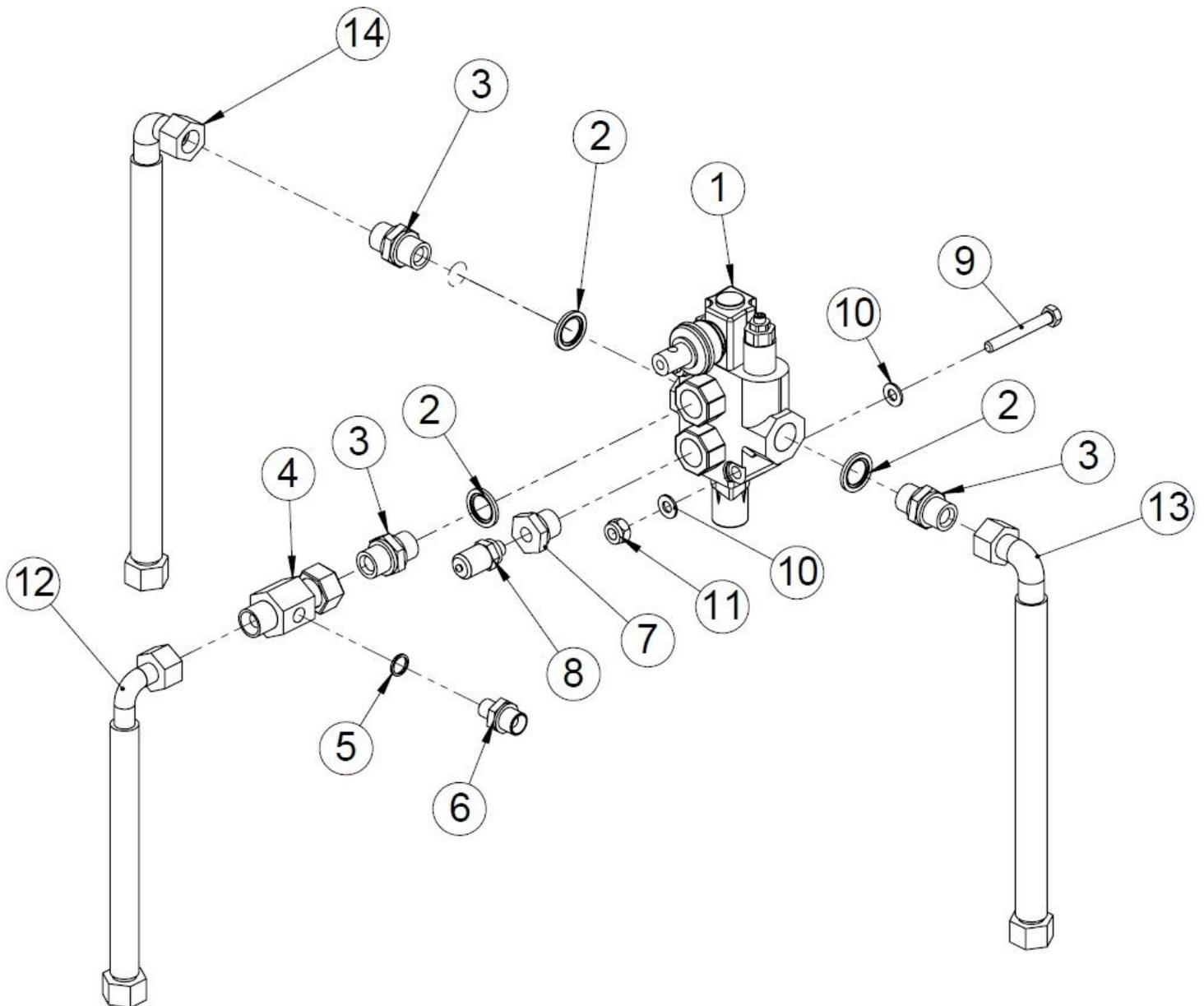

No.	Item	Part number	Dimensions	Pcs
14	Hydraulic hose	97014	1/2" x 750	1
13	Hydraulic hose	97108	1/2" x 650	1
12	Hydraulic hose	97058	1/2" x 1,500	1
11	Locking nut	96068	M10	2
10	Washer	96061	A8	4
9	Hex screw	96126	M8x60	2
8	Pressure measurement fitting	97378	1/4"	1
7	Reducer fitting	97580	1/2" x 1/4"	1
6	Double nipple	97201	1/4" x 3/8"	1
5	Copper washer 13	97469		1
4	Connecting nipple	97390	1/2" x 1/2"	1
3	Double nipple	97204	1/2" x 1/2"	3
2	USIT	97213	1/2"	3
1	Saw valve	97821		1

1.40 High-speed valve (50018615)

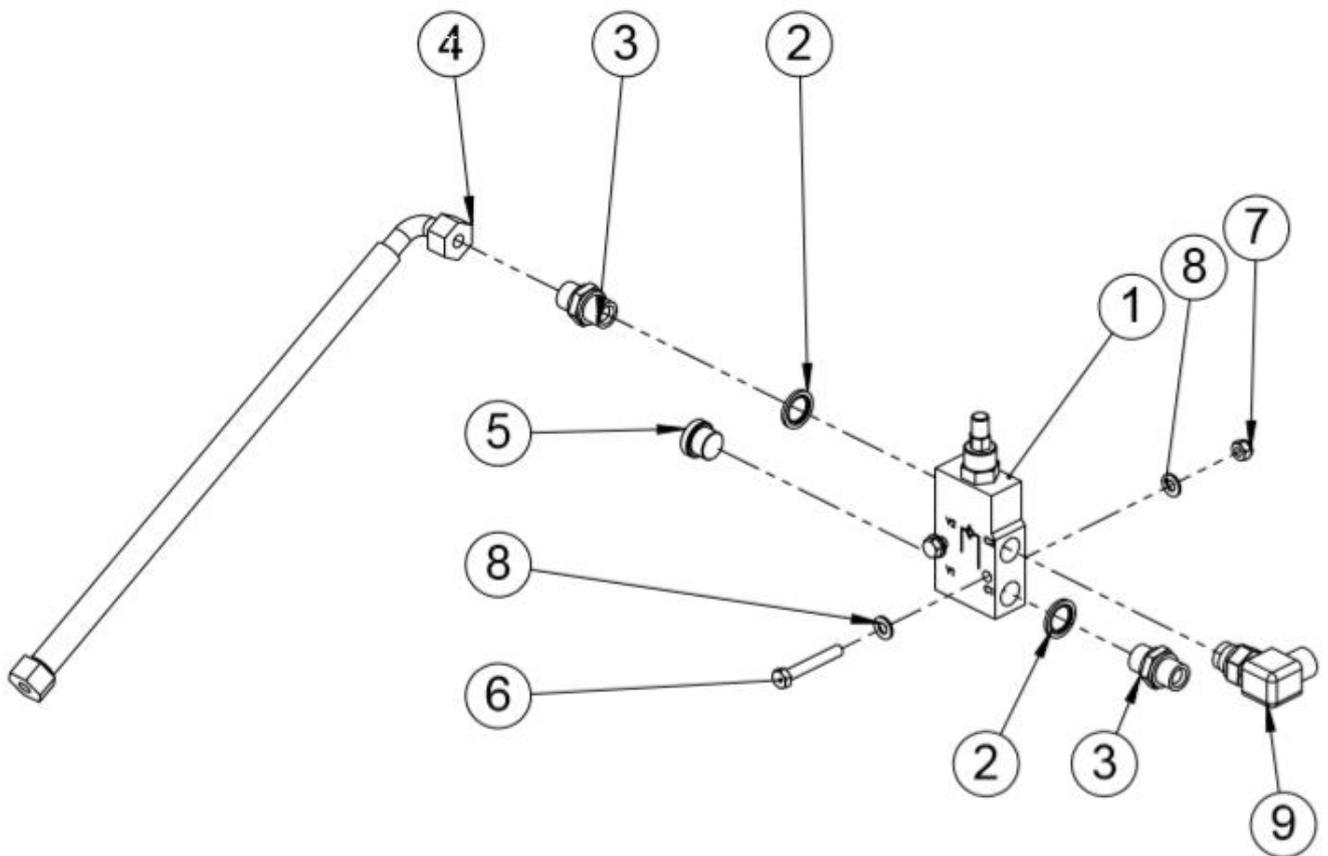

Nr.	Name	Part number	Dimension	Pc.
1	Control valve	97591		1
2	Usit 1/2"	97213		2
3	Double nipple 1/2" x 1/2"	97204		2
4	Hydraulic hose	97155	1/2"x450	1
5	Plug 1/2" uk	97261		1
6	Hex. screw	96125	M8x55	2
7	Locking nut	96222	M8	2
8	Washer	96061	A8	4
9	corner nipple 1/2"	97247		1

1.41 In-feed conveyor cock (35203, accessory)

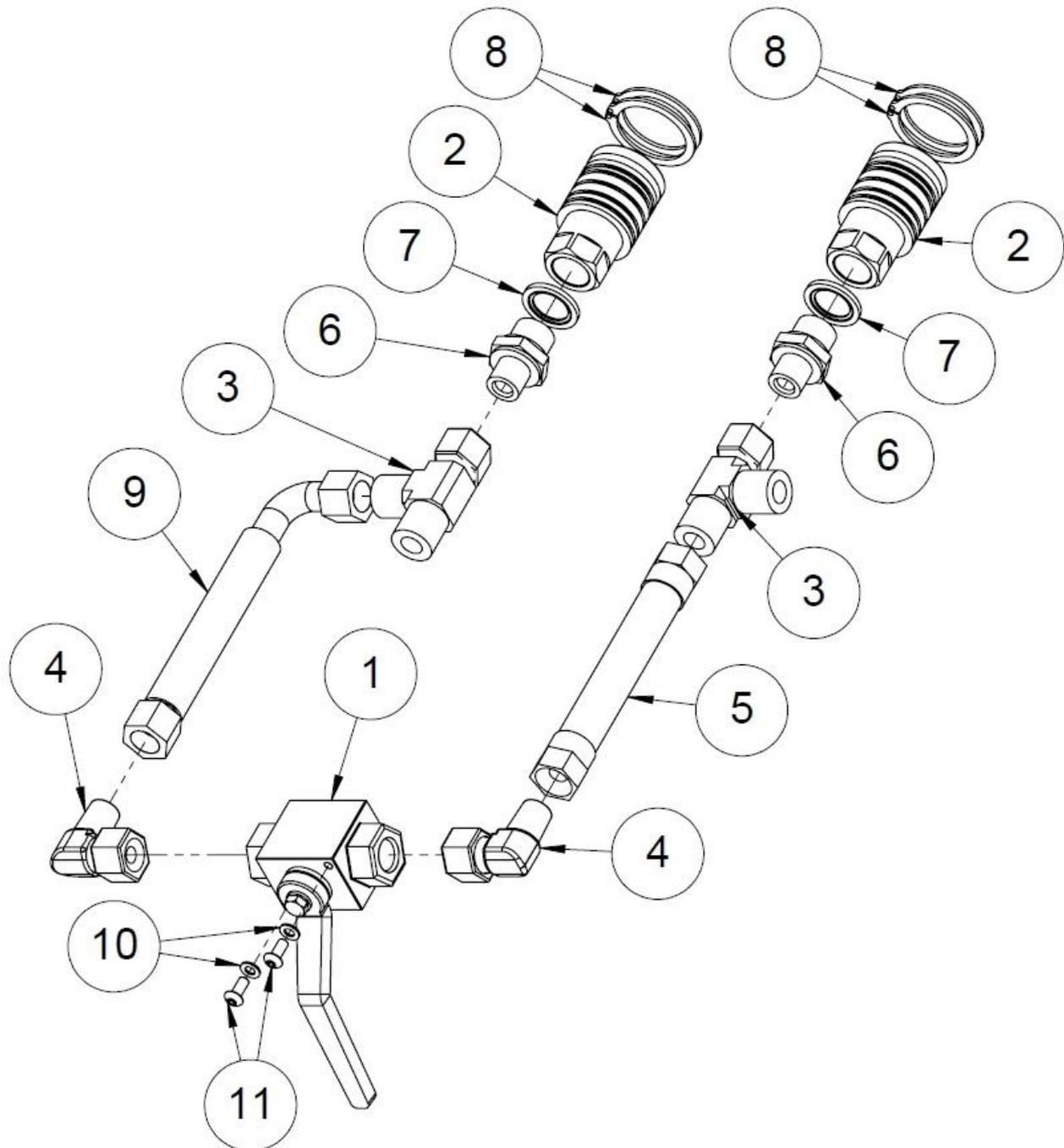

No.	Item	Part number	Dimensions	Pcs
11	Hex socket screw	96003	7380 M5x12	2
10	Washer	96055	A5	2
9	Hydraulic hose	97028	360 x 3/8"	1
8	Retaining ring	96371	38	4
7	USIT	97213	1/2"	2
6	Double nipple	97203	3/8" x 1/2"	2
5	Hydraulic hose	97018	400 x 3/8"	1
4	Directional corner nipple	97250	3/8"	2
3	T-junction (L-connector)	97234		2
2	Quick coupling, female	97388	1/2"	2
1	Ball valve	50000298	3/8"	1

1.42 Out-feed conveyor relief valve (50036562)

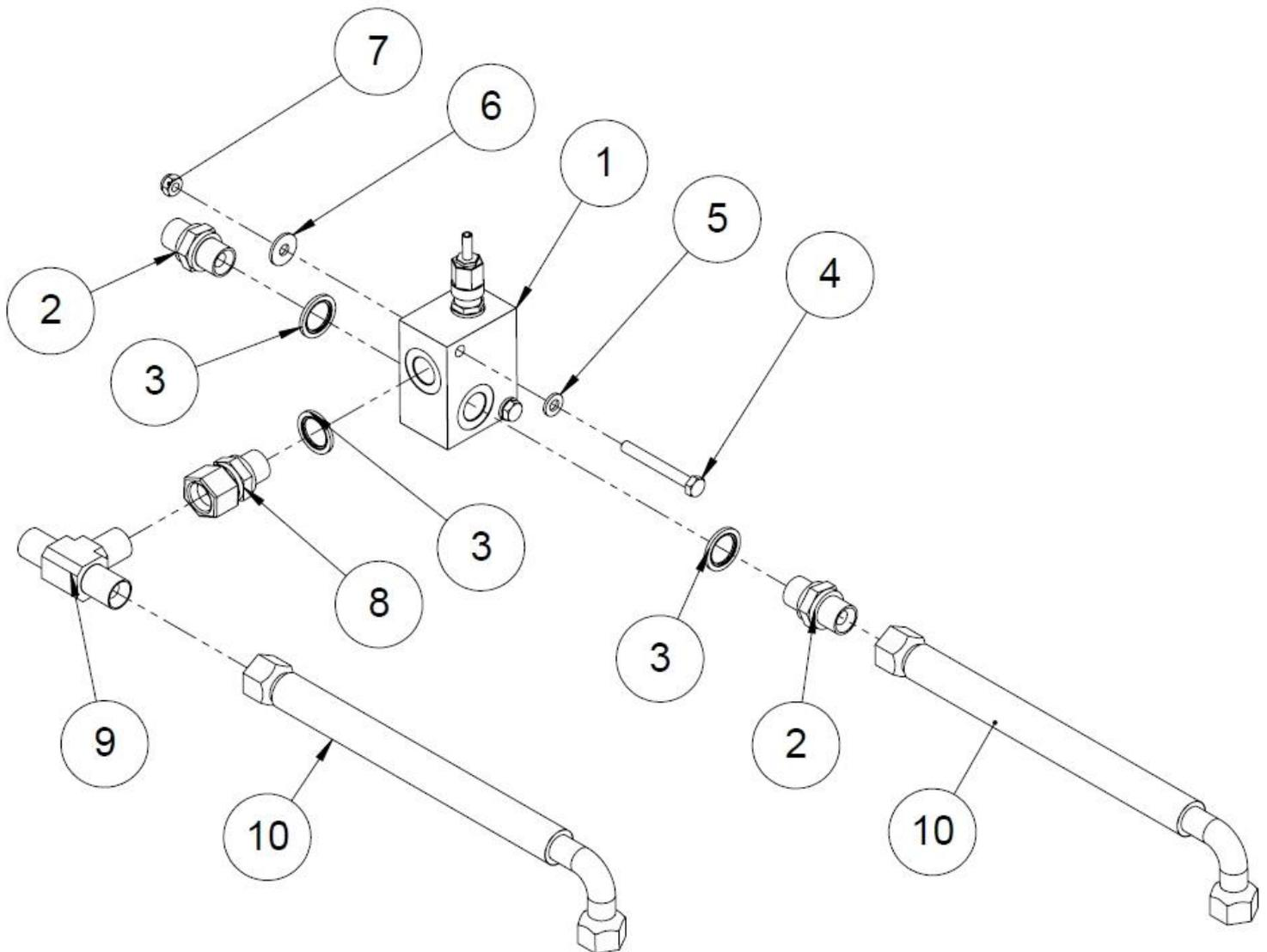

No.	Item	Part number	Dimensions	Pcs
10	Hydraulic hose	97025	3/8" x 1,000	2
9	T-junction	97226	3/8"	1
8	Connecting nipple	97219	3/8" x 3/8"	1
7	Locking nut	96221	M6	2
6	Washer	96084	M6	2
5	Washer	96060	A6	2
4	Hex screw	96119	M6x50	2
3	USIT	97212	3/8"	3
2	Double nipple	97202	3/8" x 3/8"	2
1	Relief valve	97411		1

1.43 Electric motor assembly (50008305)

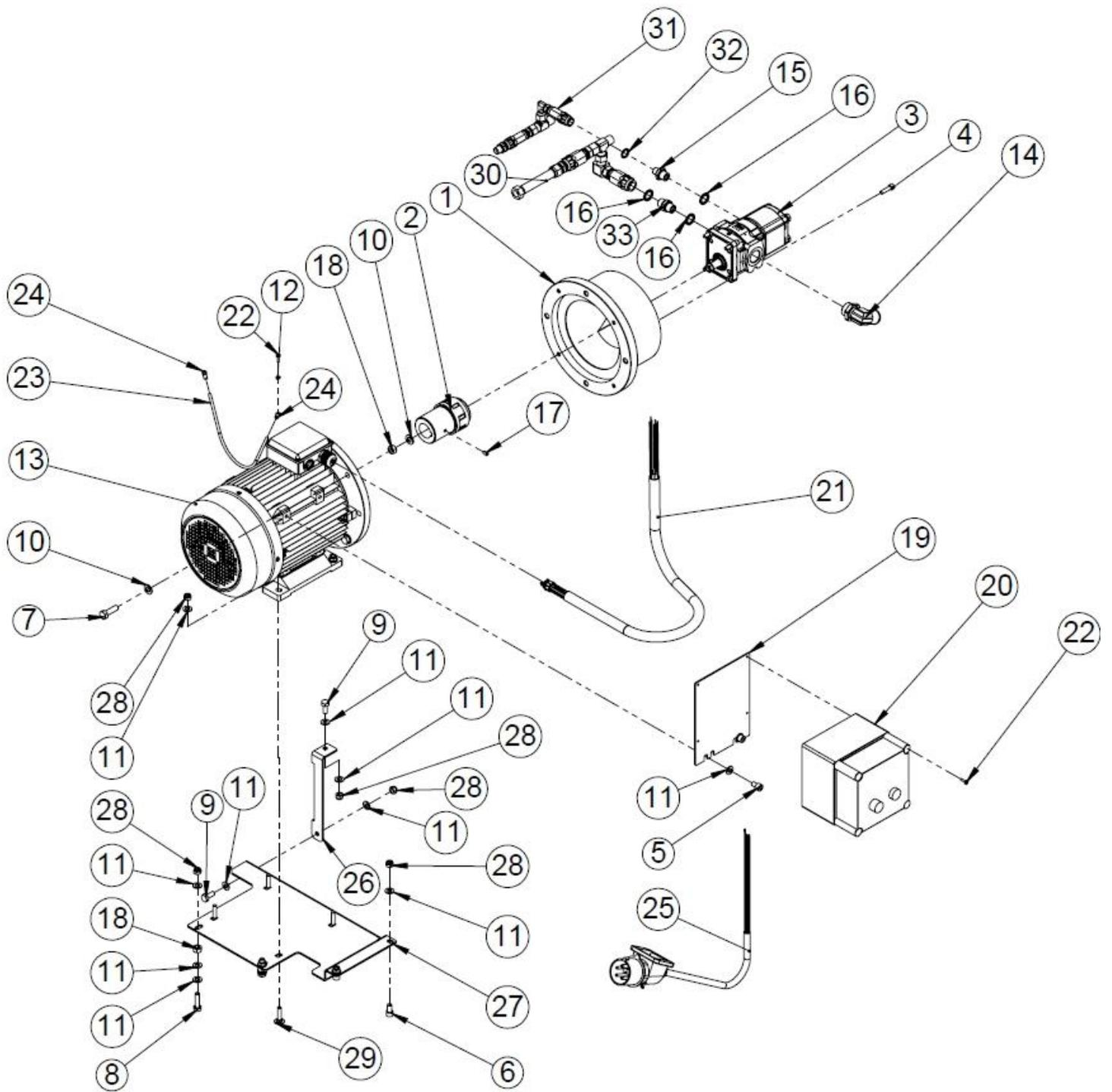

1.44 Parts list of the electric motor assembly (50008305)

No.	Item	Part number	Dimensions	Pcs
33	Double nipple 1/2" x 1/2"	97204		1
32	USIT 3/8"	97212		1
31	Check valves, small pump	50036618		1
30	Check valves, large pump	50036619		1
29	Lock screw	96314	M10x40	4
28	Locking nut	96068	M10	10
27	Electric motor bed	50017084		1
26	Bracket	50017101		1
25	Power cable + plug	10750		1
24	Eyelet connector M6	96398		2
23	Earthing cable	95483	6mm ² x 400mm	1
22	Slot head screw	96262	M5x16 -Z	5
21	Rubber cable 7x1.5mm	95661		1
20	Starter 7.5 kW	95152		1
19	Fastening plate	50017079	PL3 x	1
18	Hex nut	96200	M12	3
17	Clamping screw	96227	M8x12	1
16	USIT 1/2"	97213		3
15	Double nipple 3/8" x 1/2"	97203		1
14	Suction connector 1"/32 mm	97849		1
13	7.5kw electric motor	95039		1
12	Washer	96055	A5	1
11	Washer	96049	A10	18
10	Washer	96058	A12	5
9	Hex screw	96139	M10x25	2
8	Hex screw	96129_	M10x40	2
7	Hex screw	96148	M12x40	4
6	Hex socket screw	96022	M10x20	2
5	Hex socket screw	96024	M10x16	2
4	Hex socket screw	96341	M8x30	4
3	Hydraulic pump	97325	08/2018-->	1
2	Intermediate switch	97351		1
1	Motor flange	97350		1

1.45 Saw downward pressure control valve assembly (50033694)

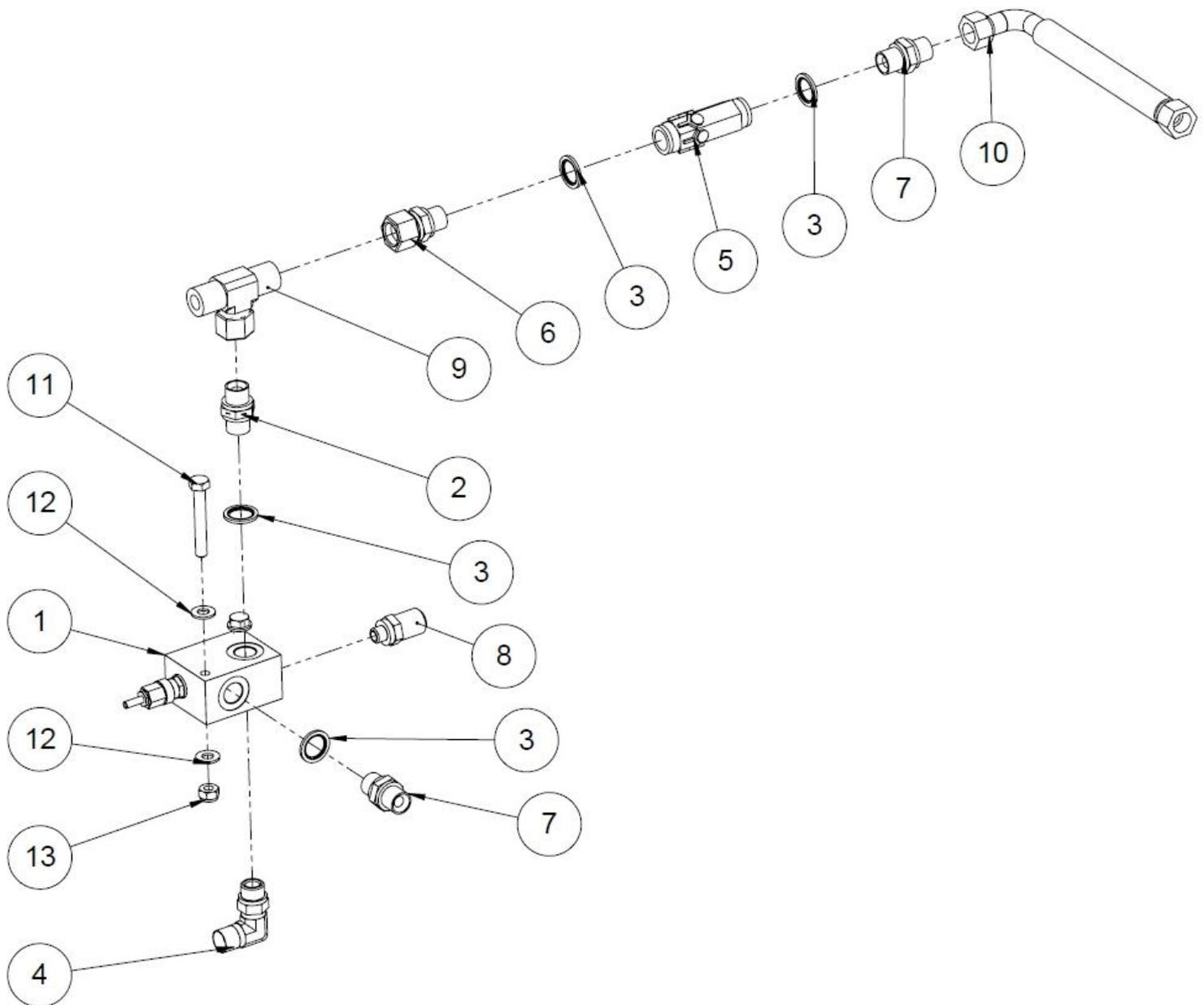

No.	Item	Part number	Dimensions	Pcs
13	Locking nut	96222	M8	2
12	Washer	96061	A8	4
11	Hex screw	96125	M8x55	2
10	Hydraulic hose	97044	3/8" x 450	1
9	T-connector	97230	3/8"	1
8	Pressure measurement fitting	97378	1/4"	1
7	Double nipple	97202	3/8" x 3/8"	2
6	Connecting nipple	97219	3/8" 3/8"	1
5	Check valve	97251	3/8" 0.5 bar	1
4	Elbow nipple	97250	3/8"	1
3	USIT	97212	3/8"	4
2	Choke nipple	97276	3/8" 1 mm	1
1	Relief valve	97634	3/8"	1

1.46 Relief valve (50033695)

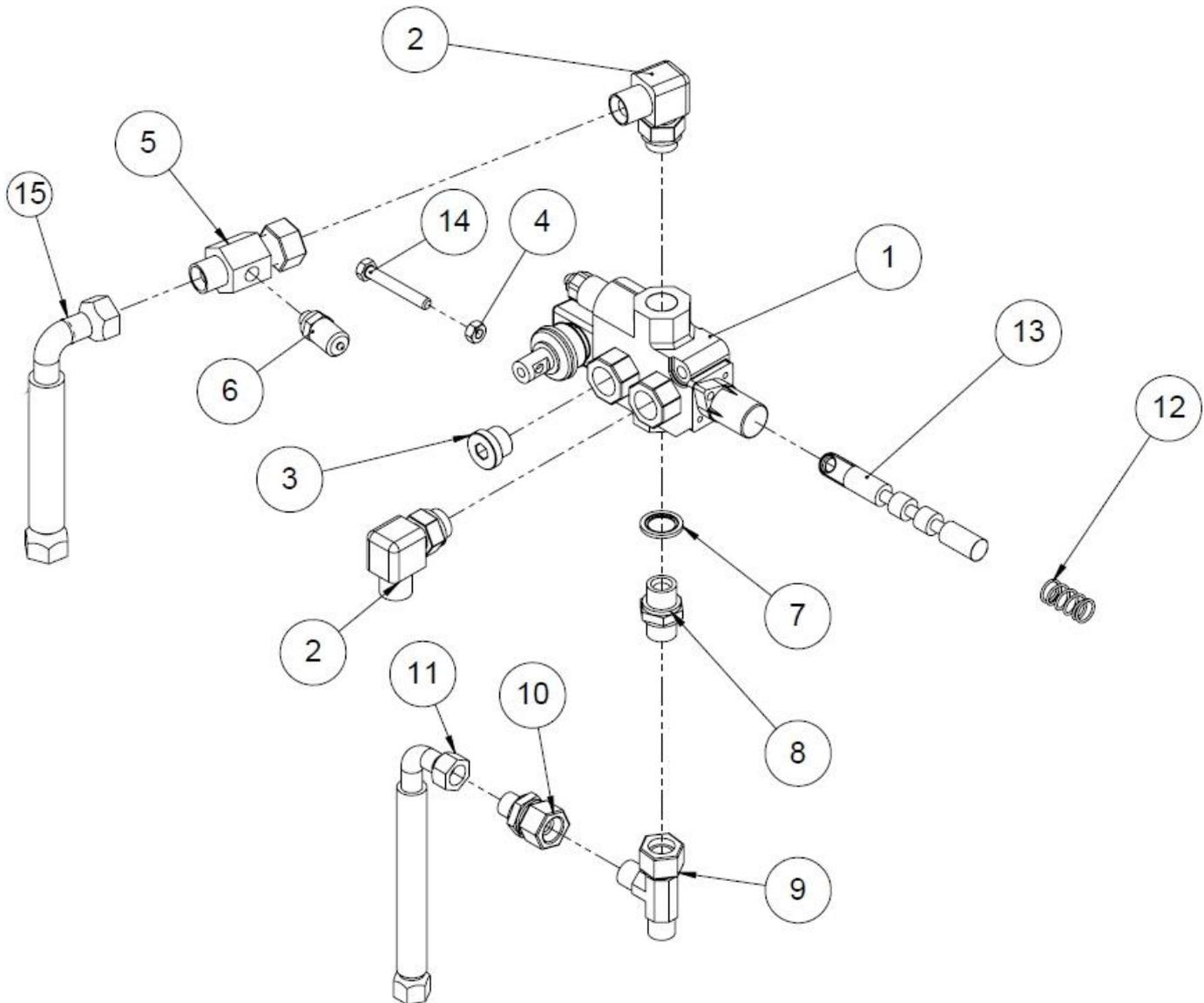

Nr.	Item	Part number	Dimensions	Pcs
1	Valve	97748		1
2	Angle nipple	97247	1/2"	2
3	Plug	97261	1/2"	1
4	Hex nut	96196	M8	1
5	Connection nipple	97390	1/2" x 1/2" 1/4"	1
6	Nipple for pressure measuring	97378	1/4"	1
7	O-ring	97213	1/2"	1
8	Nipple	97204	1/2" x 1/2"	1
9	L-coupling	97228	1/2"	1
10	Nipple	97218	3/8" x 1/2"	1
11	Hydraulic hose	97044	450x 3/8", 350 bar	1
12	Draw spring Ø1,6x 17,2 x33	95290		1
13	Shaft of valve SD 4-1	97907		1
14	Hex screw	96125	M8x55	1
15	Hydraulic hose	97013	1000 x 1/2"	1

1.47 Control valve of splitting blade, Accessory

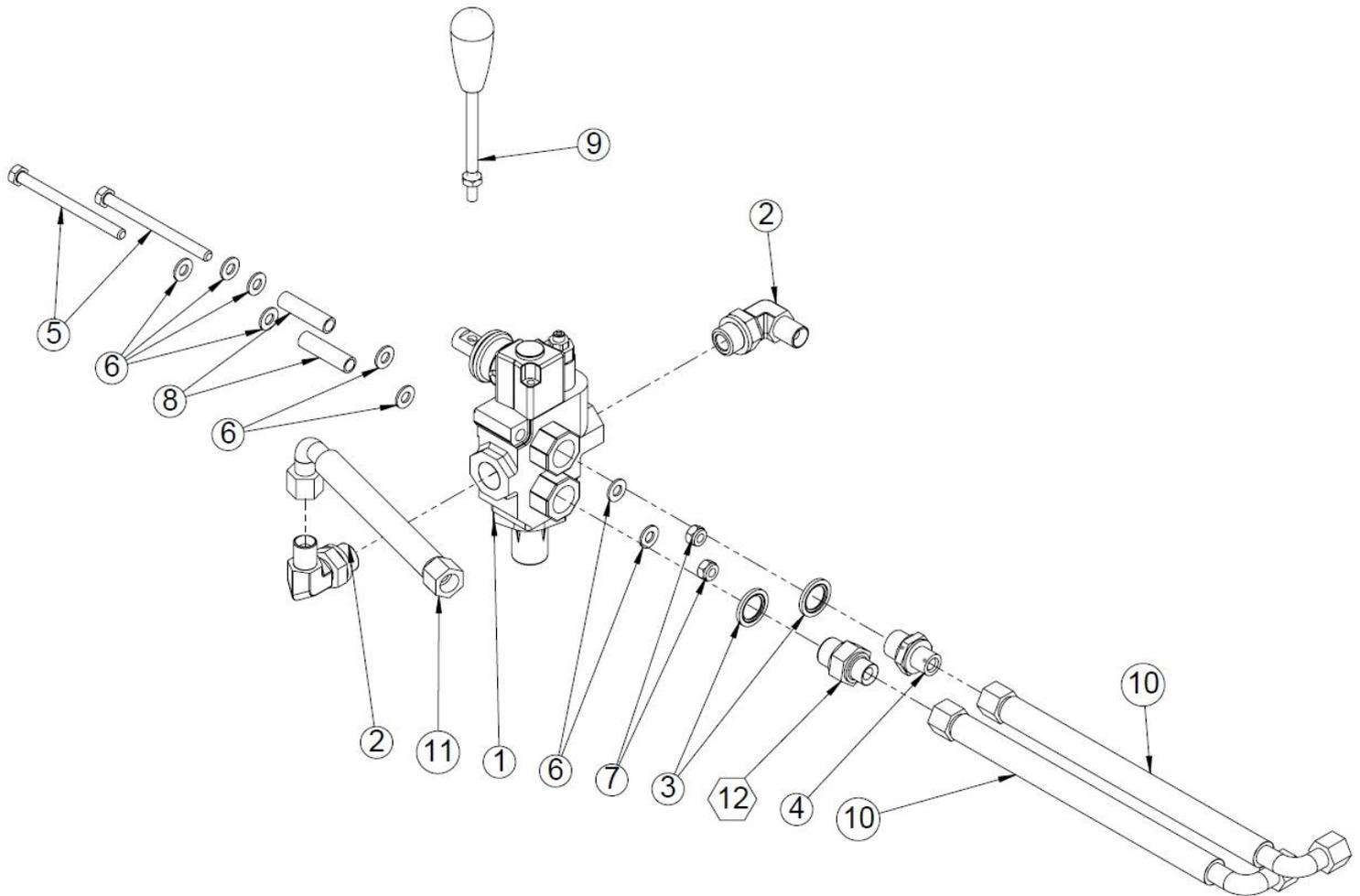

Nr.	Name	Part number	Dimension	Pcs
1	Control valve	97842		1
2	Nipple 1/2" uk x 3/8" uk	97610	1/2" x 3/8"	2
3	Usit- seal	97213	1/2"	2
4	Double nipple	97203	3/8" x 1/2"	1
5	Hex screw	96414	M8x100	2
6	Washer	96061	A8	8
7	Locking nut	96222	M8	2
8	Pipe	50042140		2
9	Lever	97423		1
10	Hydraulic hose	97045	1600 x 3/8"	2
11	Hydraulic hose	97008	700x 3/8"	1
12	Nipple	97393	3/8" x 1/2", 1mm	1

1.48 Hydraulic control for splitting blade, accessory (50042223)

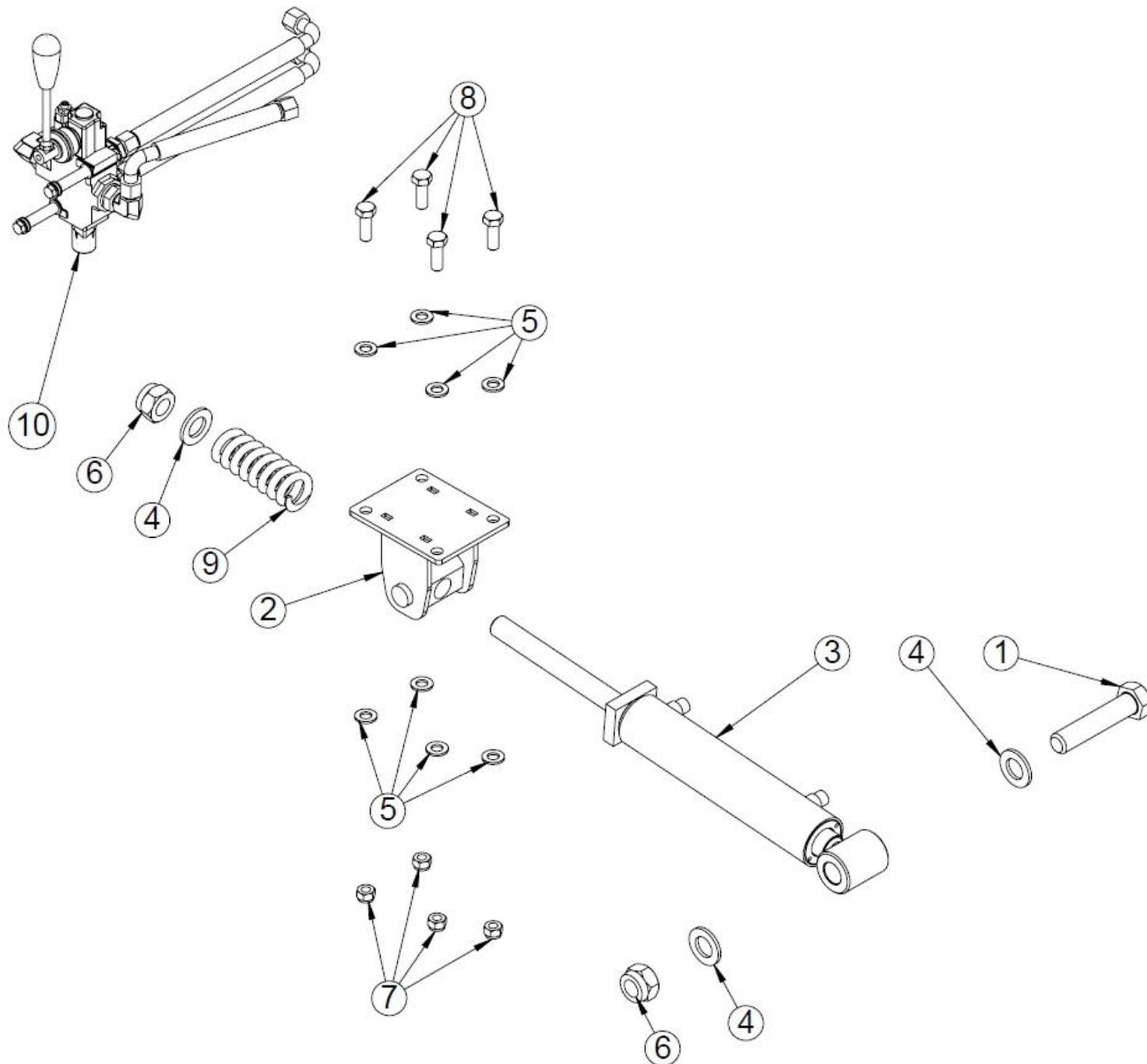

Nr.	Name	Part number	Dimension	Pcs
1	Hex. Screw	96429	M24x110	1
2	Attachment part of cylinder	50040757		1
3	Cylinder of splitting blade control	60915		1
4	Washer	96054	A24	3
5	Washer	96058	A12	8
6	Locking nut	96214	M24	2
7	Locking nut	96218	M12	4
8	Hex. screw	96147	M12x35	4
9	Spring	95026	Ø26-9-120	1
10	Control valve kit	50040806		1

1.49 Splitting blade height adjustment lever

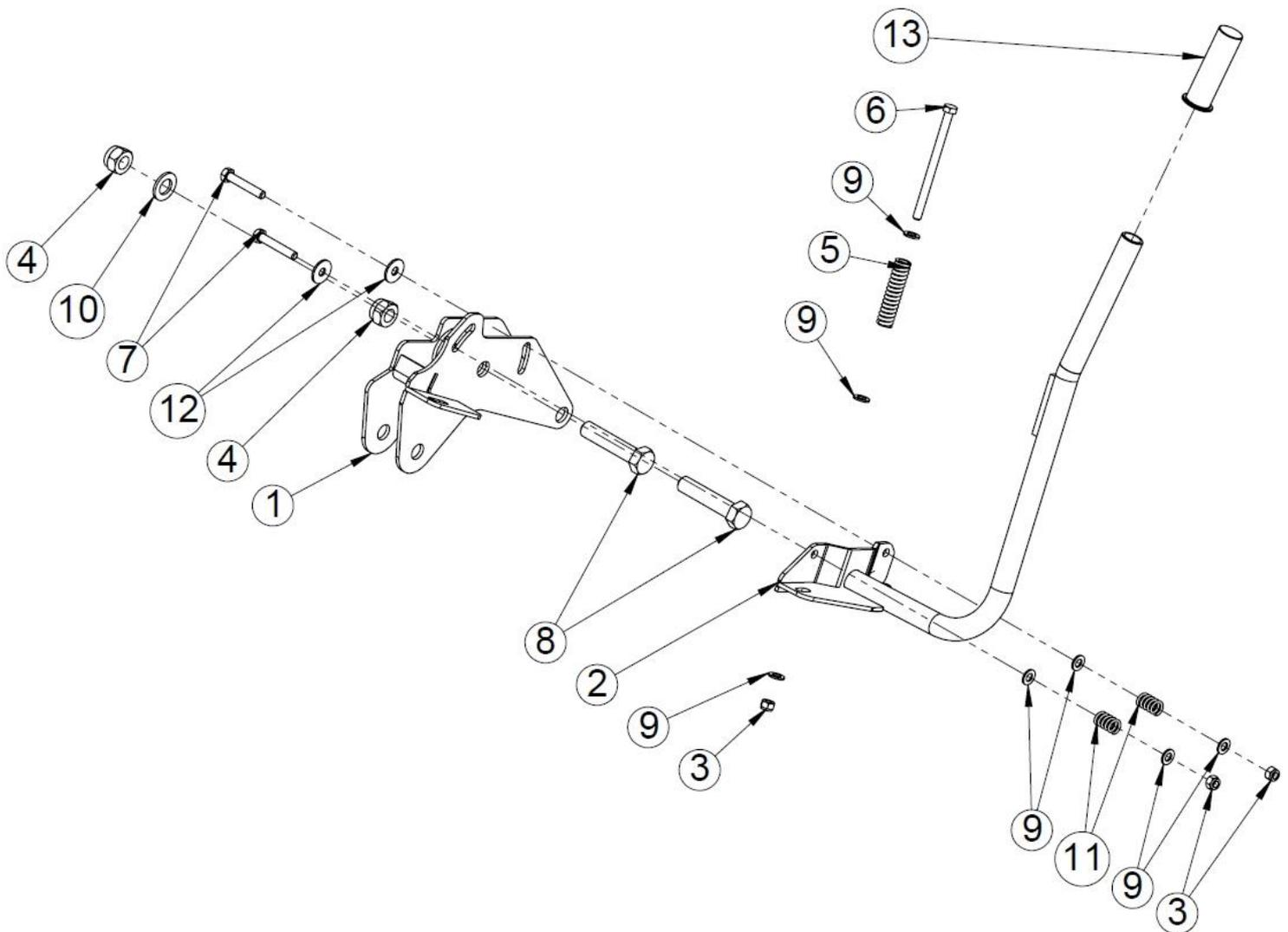

Nro	Nimi	Osanumero	Mitat	Kpl
1	Adjuster of splitting blade	50042991		1
2	Handle	50025177		1
3	Locking nut	96218	M12	3
4	Locking nut	96214	M24	2
5	Spring	95017	5x 25x125	1
6	Hex. Screw	96578	M12x170	1
7	Hex. Screw	96110	M12x70	2
8	Hex. Screw	96429	M24x110	2
9	Washer	96058	A12	7
10	Washer	96054	A24	2
11	Spring	95014	3,5x22x38mm	2
12	Washer	96340	M12	2
13	Grip	95648	32mm	1

1.50 Splitting cylinder check valve on the arm side (50018545)

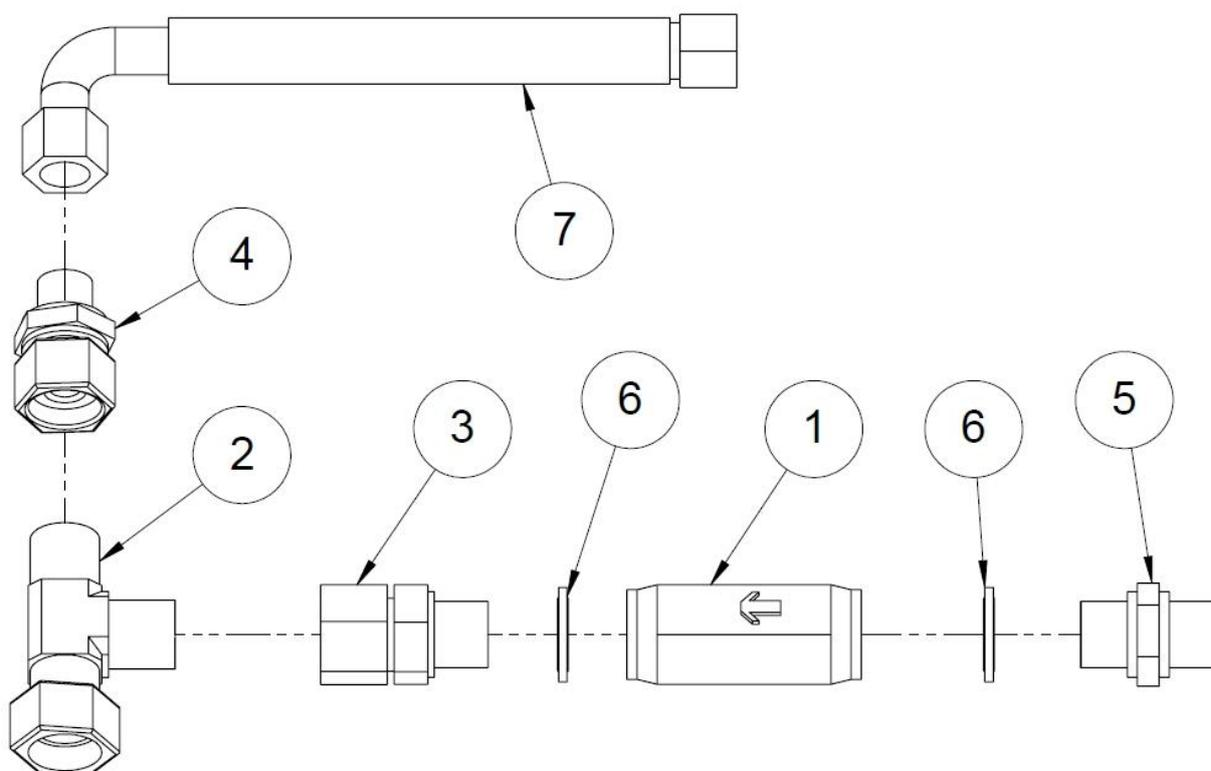

No.	Item	Part number	Pcs
7	Hydraulic hose 700 mm x 3/8"	97008	1
6	USIT 1/2"	97213	2
5	Double nipple 1/2" x 1/2"	97204	1
4	Connecting nipple 1/2" x 3/8"	97218	1
3	Connecting nipple 1/2" x 1/2"	97216	1
2	Adjustable L connector	97228	1
1	Check valve 1/2"	97252	1

1.51 Divider

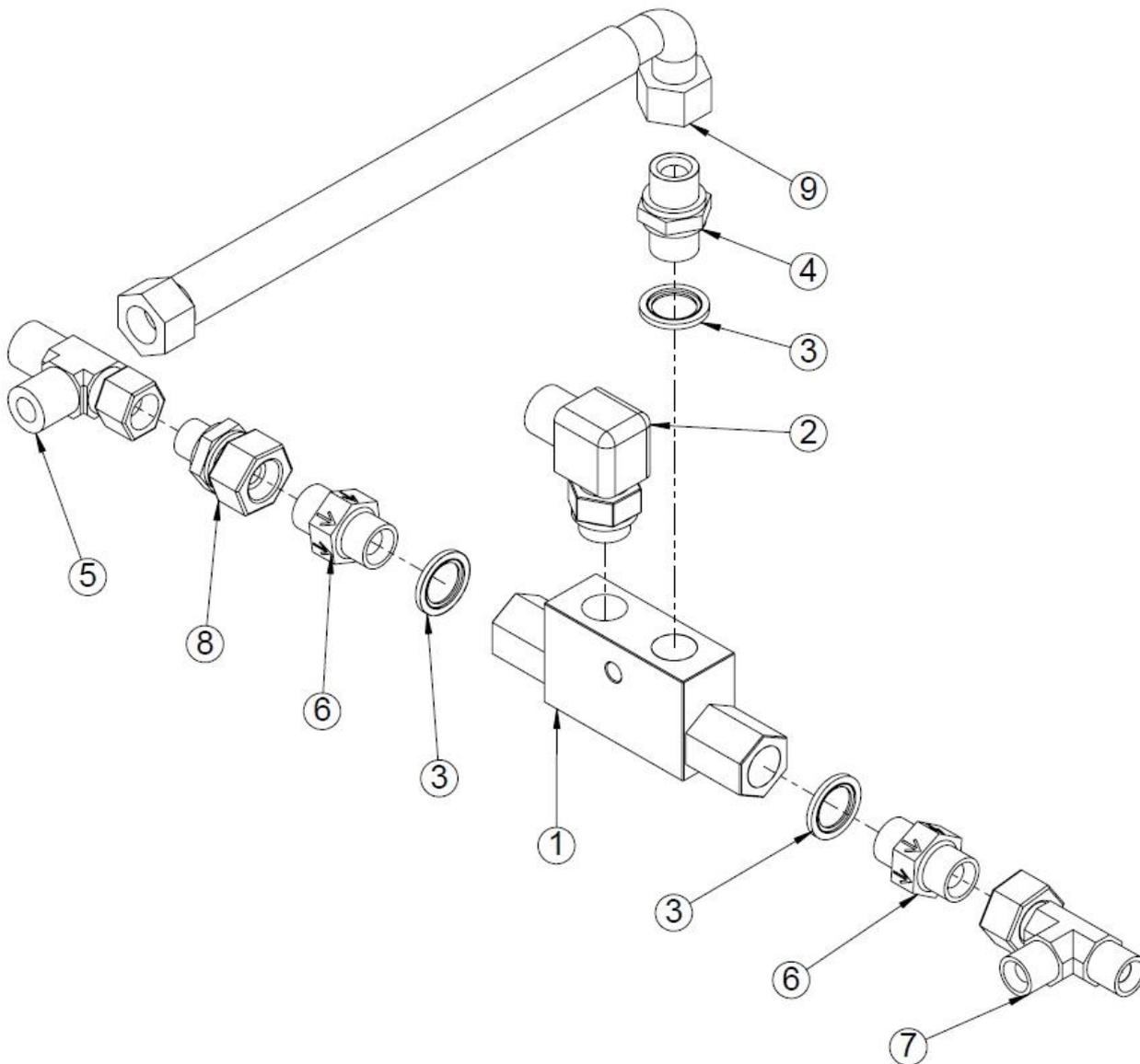

Nr.	Name/dimension	Part number	Pcs
9	Hydraulic hose 650 x 1/2"	97108	1
8	Connection nipple, 3/8" x 1/2"	97218	1
7	L-coupling 1/2"	97228	1
6	Double nipple 1/2"	97653	2
5	L-coupling 3/8"	97234	1
4	Double nipple 1/2" x 1/2"	97204	1
3	Usit- seal 1/2"	97213	3
2	Corner nipple 1/2"	97247	1
1	Divider	97931	1

1.52 Small pump check valve (50036618) (Combi model only)

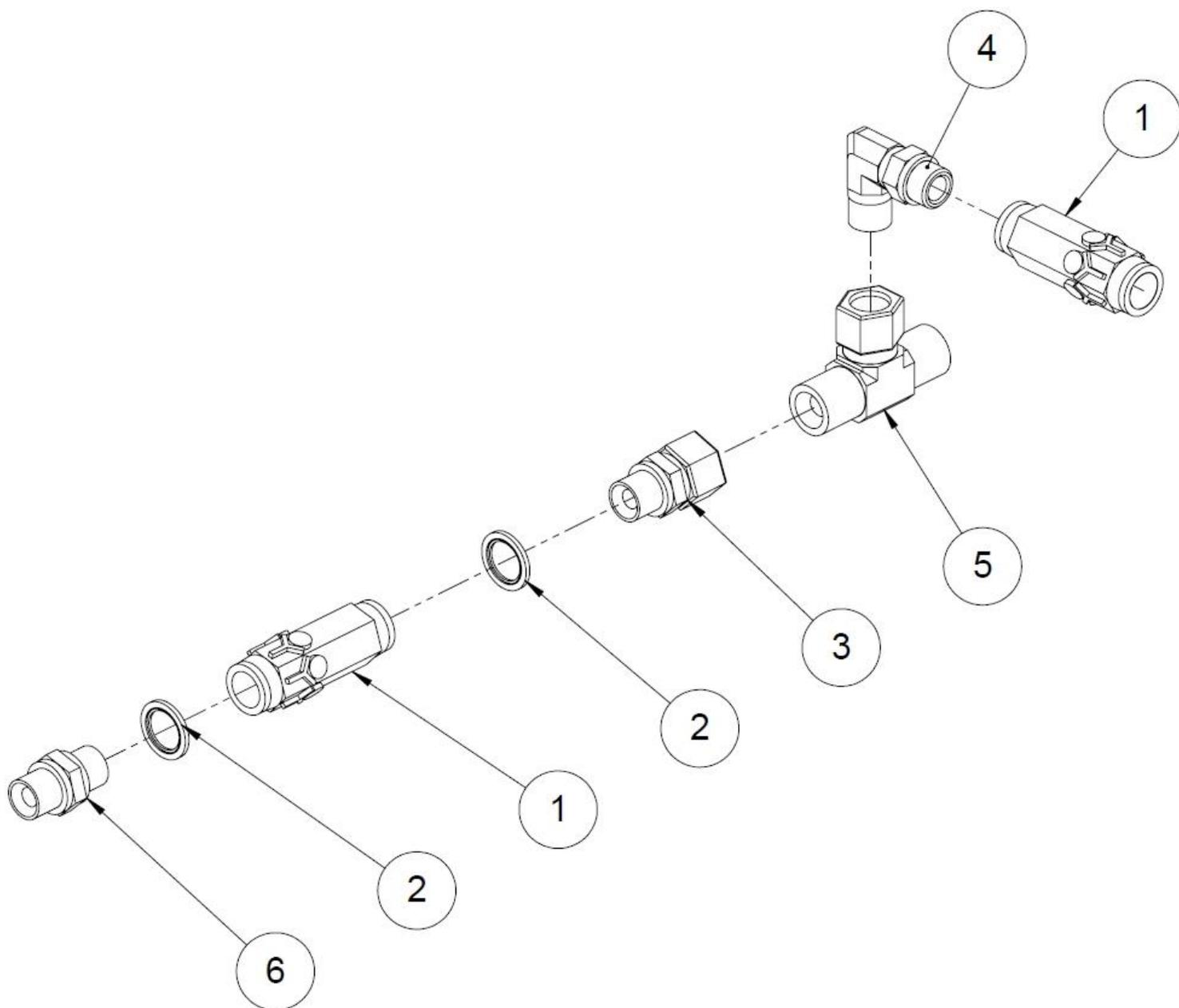

No.	Item	Part number	Pcs
6	Double nipple 3/8" x 3/8"	97202	1
5	T-connector 3/8"	97230	1
4	Elbow nipple 3/8"	97250	1
3	Connecting nipple 3/8" x 3/8"	97219	1
2	USIT 3/8"	97212	2
1	Check valve 3/8" 0.5 bar	97251	2

1.53 Large pump check valve (50036619) (Combi model only)

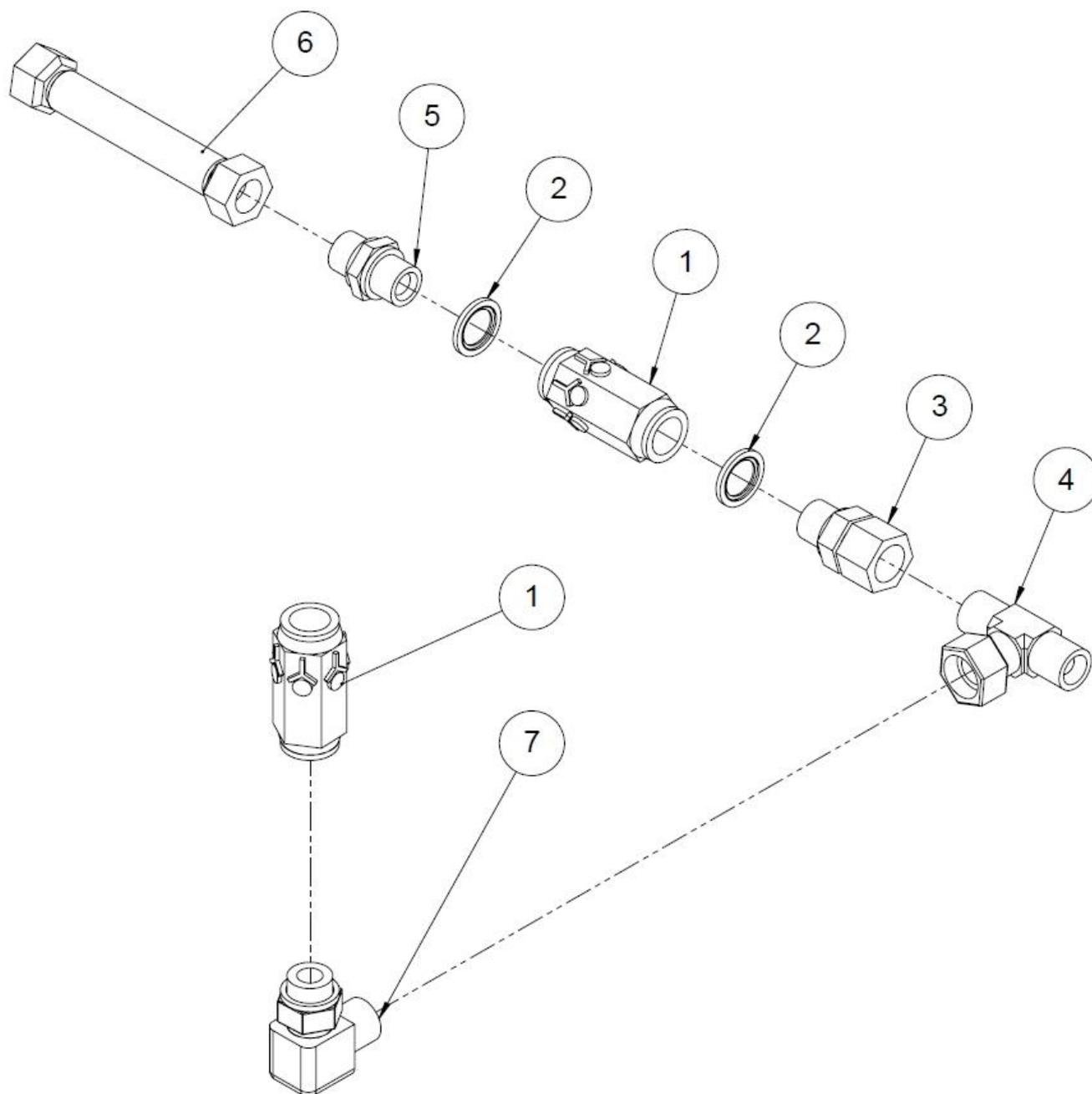

No.	Item	Part number	Dimensions	Pcs
7	Directional elbow nipple	97247	1/2"	1
6	Hydraulic hose	97099	1/2" x 650	1
5	Double nipple	97204	1/2" x 1/2"	1
4	Adjustable T connector	97229	1/2"	1
3	Connecting nipple	97216	1/2" x 1/2"	1
2	USIT	97213	1/2"	2
1	Check valve	97252	1/2" 0.5 bar	2

1.54 Saw control valve, accessory (50044723)

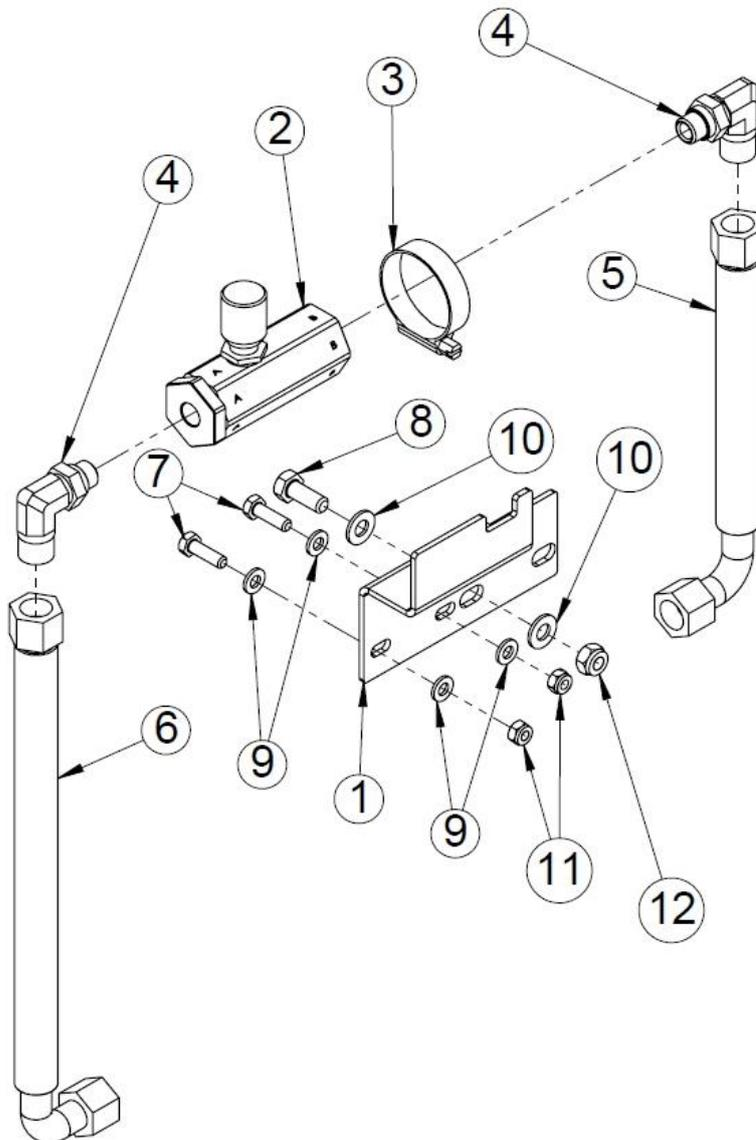

Nro	Nimi	Osanumero	Mitat	Kpl
1	Venttiilin kiinnityslevy	50018716	PL3	1
2	Säädin R1/4"	97597	R1/4"	1
3	Hose clamp	96394	ABA 32-44	1
4	Corner nipple	97755	1/4" / 3/8"	2
5	Hydraulic hose	97185	550 x 3,8"	1
6	Hydraulic hose	97045	1600 x 3/8"	1
7	Hex. Scerw	96135	M6x20	2
8	Hex. Screw	96161	M8x20	1
9	Washer	96060	A6	4
10	Washer	96061	A8	2
11	Locking nut	96221	M6	2
12	Locking nut	96222	M8	1

1.55 Auxiliary device control valve (37638, accessory)

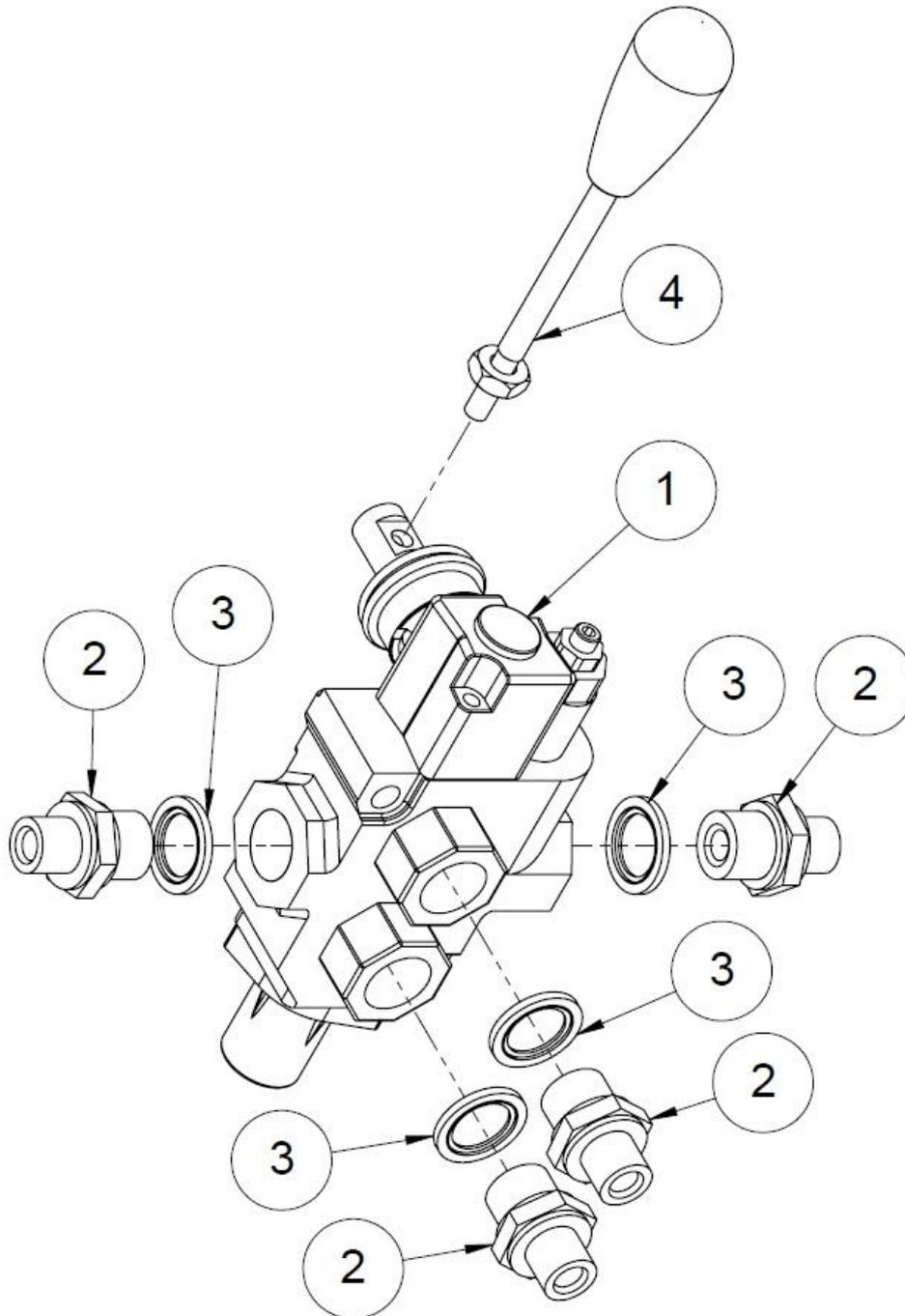

No.	Item	Part number	Pcs
4	Lever (AL01, M8, 120)	97423	1
3	USIT ½"	97213	4
2	Double nipple, straight 3/8" x ½"	97203	4
1	Valve	97842	1

1.56 Log table extra roller (35209, accessory)

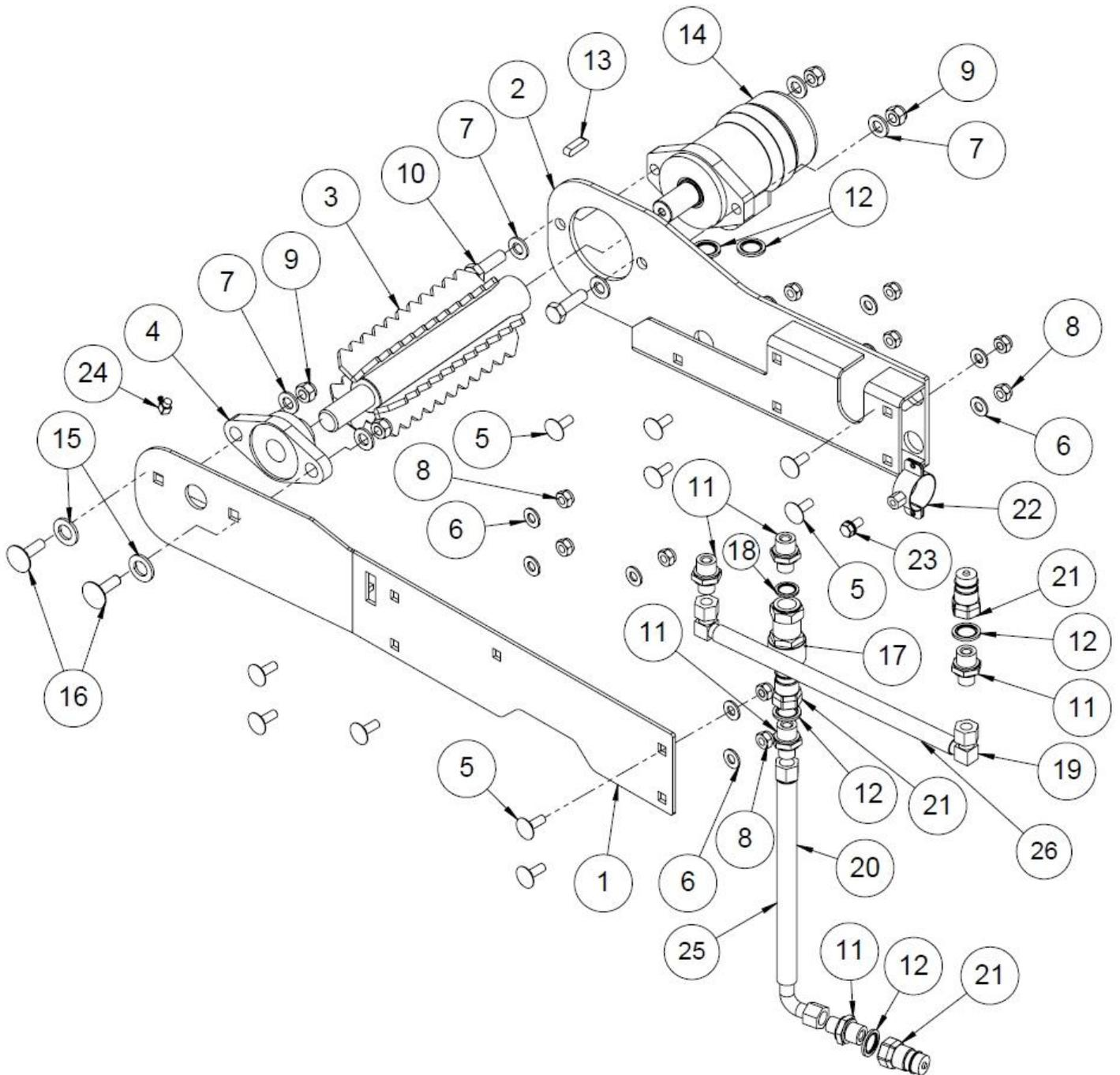

1.57 Parts list of the log table extra roller (35209, accessory)

No.	Item	Part number	Dimensions	Pcs
26	Protective hose 40 mm	97270	2,000 mm	1
25	Protective hose 25 mm	97268	2,000 mm	1
24	Lubrication nipple	96275	M8x1 90 GR	1
23	Flange bolt M8x16	96172		1
22	Pipe clamp 39-44 mm			1
21	Quick coupler male	97209		3
20	Hydraulic hose	97095	2,200 x 3/8", straight/90	1
19	Hydraulic hose	97090	1,900 x 3/8", 90/90	1
18	USIT	97212	3/8"	1
17	Quick coupling, female	97210		1
16	Lock screw	96399	M12x35	2
15	Washer	96059	A16	2
14	Hydraulic motor	97308	MSEPM-200	1
13	Wedge for hydr. motor	97371		1
12	USIT	97213	1/2"	5
11	Double nipple	97203	3/8" x 1/2", straight	5
10	Hex screw	96148	M12x40	2
9	Locking nut	96218	M12	4
8	Locking nut	96068	M10	10
7	Washer	96058	A12	6
6	Washer	96049	A10	10
5	Lock screw	96186	M10x25	10
4	Collar step bearing unit	95057	UCFL 205	1
3	Auxiliary roller	50004097		1
2	Motor fastening	50020403		1
1	Bearing fastening	50020402		1